

Section 6

Stand-Alone Access Control

RF Controls

MicroPlus RF Controls	2
MicroCLIK RF Controls	4
Simple RF Control Sets.....	6

Card Readers / Keypads / Key Switches

Model 1520 Single Door Controller	7
Model 1506 Deluxe Keypads	8
Model 1503 Basic Keypads	9
Model 1200 Series Key Switches	10

Accessories, Replacement Components

Mounting Posts	11
Postal / Fire Department Lock Boxes	12
Exit Push Buttons.....	13
Time Clocks & Surge Suppressers.....	14
Accessory Transformers	15
Replacement Components	16

MicroPLUS

Stand-Alone RF Controls

MicroPLUS RF controls are designed to provide maximum RF code security. There are over 268 million transmitter codes available, plus an encrypted sync code that changes each time the transmitter is used. These RF controls are ideal for gated communities, apartment complexes, business offices and industrial sites. MicroPLUS codes cannot be copied, making them ideal for use in security sensitive areas.

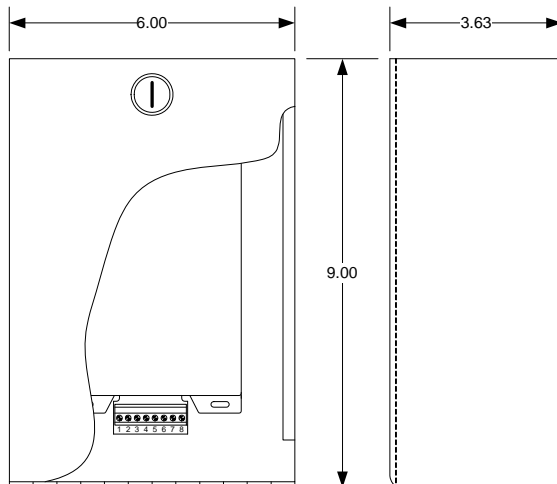
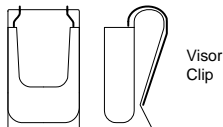
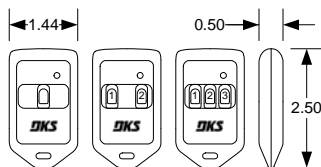
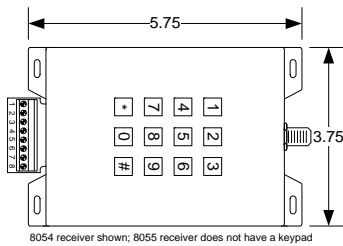

8057-110

8054 Receiver

8054-081 50 Transmitter Codes.....	324.00
8054-082 100 Transmitter Codes.....	380.00
8054-083 250 Transmitter Codes.....	432.00
8054-084 500 Transmitter Codes.....	484.00
8054-085 1000 Transmitter Codes.....	540.00
8054-086 1250 Transmitter Codes.....	592.00

- Built-in time clock, 10 programmable time zones
- Single pole relay
- Stores up to 2300 transactions
- Can be connected to a serial printer

8055 Receiver

8055-080 40 Transmitter Codes.....	86.00
8055-081 40 Transmitter Codes w/Coax Antenna Kit..	108.00

- Single pole relay
- Programming by the "learn" method
- Individual transmitter codes cannot be deleted

MicroPlus Receiver Accessories

1514-073 Coax Antenna Kit	48.00
• Includes mounting bracket, antenna, 15-foot coax cable	
8058-080 Antenna Amplifier.....	160.00
• Amplifies and filters 318 MHz RF signal. Includes 20-foot coax cable.	
1514-072 High Gain Antenna.....	172.00
• High gain Yagi directional antenna, 300-330 MHz range. Includes 15-foot coax cable.	
8057-110.....	96.00
• Lockable, metal outdoor enclosure for RF receivers (does not include receiver)	
8060-076.....	17.50
• Plastic outdoor enclosure for RF receivers	
1508-048 Printer.....	810.00
• Use with 8054 receivers only	

MicroPlus Transmitters

IMPORTANT! The prices shown are for block-coded transmitters ordered in multiples of 10 only. Add \$3.00 per transmitter for any order specifying transmitter numbering sequence or facility codes.

MicroPlus Transmitters	
8069-080 1 Button	
10-30.....	36.00
40-100.....	34.00
110+.....	30.00
8070-080 2 Button	
10-30.....	38.00
40-100.....	36.00
110+.....	32.00
8071-080 3 Button	
10-30.....	40.00
40-100.....	38.00
110+.....	34.00

MicroPlus PROXmitters with DKS Tag	
8069-086 1 Button	
10-30.....	44.00
40-100.....	42.00
110+.....	38.00
8070-086 2 Button	
10-30.....	46.00
40-100.....	44.00
110+.....	40.00
8071-086 3 Button	
10-30.....	48.00
40-100.....	46.00
110+.....	42.00

MicroPlus PROXmitters with AWID Tag	
8069-082 1 Button	
10-30.....	44.00
40-100.....	42.00
110+.....	38.00
8070-082 2 Button	
10-30.....	46.00
40-100.....	44.00
110+.....	40.00
8071-082 3 Button	
10-30.....	48.00
40-100.....	46.00
110+.....	42.00

MicroPlus PROXmitters with HID Tag	
8069-084 1 Button	
10-30.....	44.00
40-100.....	42.00
110+.....	38.00
8070-084 2 Button	
10-30.....	46.00
40-100.....	44.00
110+.....	40.00
8071-084 3 Button	
10-30.....	48.00
40-100.....	46.00
110+.....	42.00

MicroPlus Visor Clips (Black)	
8069-075	
1-30.....	3.30
31-100.....	2.80
101+.....	2.30

MicroClik

Stand-Alone RF Controls

MicroClik RF controls are designed to provide convenience and security. MicroClik transmitters are factory coded to 1 of over 1 million available codes. These RF controls are ideal for gated communities, apartment complexes, business offices and industrial sites. MicroClik transmitters are HomeLink compatible.

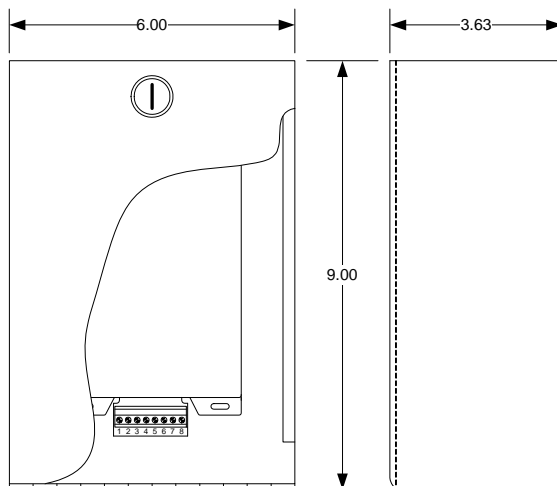
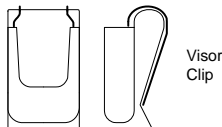
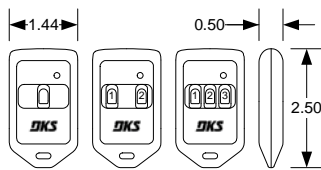
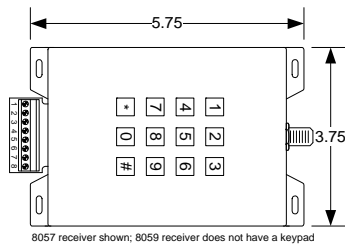

8057-110

8057 Receiver

8057-081 50 Transmitter Codes.....	270.00
8057-082 100 Transmitter Codes.....	324.00
8057-083 250 Transmitter Codes	376.00
8057-084 500 Transmitter Codes	432.00
8057-085 1000 Transmitter Codes.....	484.00
8057-086 5000 Transmitter Codes.....	540.00
8057-088 16,000 Transmitter Codes.....	592.00

- 10 facility codes
- Single pole relay

8059 Receiver

8059-080 80 Transmitter Codes.....	160.00
------------------------------------	--------

- Single pole relay
- Programming by the “learn” method
- Individual transmitter codes cannot be deleted

MicroClik Receiver Accessories

1514-073 Coax Antenna Kit	48.00
---------------------------------	-------

- Includes mounting bracket, antenna, 15-foot coax cable

8058-080 Antenna Amplifier.....	160.00
---------------------------------	--------

- Amplifies and filters 318 MHz RF signal. Includes 20-foot coax cable.

1514-072 High Gain Antenna.....	172.00
---------------------------------	--------

- High gain Yagi directional antenna, 300-330 MHz range. Includes 15-foot coax cable.

8057-110.....	96.00
---------------	-------

- Lockable, metal outdoor enclosure for RF receivers (does not include receiver)

8060-076.....	17.50
---------------	-------

- Plastic outdoor enclosure for RF receivers

MicroClik Transmitters

IMPORTANT! The prices shown are for block-coded transmitters ordered in multiples of 10 only. Add \$3.00 per transmitter for any order specifying transmitter numbering sequence or facility codes.

MicroClik Transmitters	
8066-080 1 Button	
10-30.....	38.00
40-100.....	36.00
110+.....	32.00
8067-080 2 Button	
10-30.....	40.00
40-100.....	38.00
110+.....	34.00
8068-080 3 Button	
10-30.....	42.00
40-100.....	40.00
110+.....	36.00

MicroClik PROXmitters with DKS Tag	
8066-084 1 Button	
10-30.....	46.00
40-100.....	44.00
110+.....	40.00
8067-084 2 Button	
10-30.....	48.00
40-100.....	46.00
110+.....	42.00
8068-084 3 Button	
10-30.....	50.00
40-100.....	48.00
110+.....	44.00

MicroClik PROXmitters with AWID Tag	
8066-082 1 Button	
10-30.....	46.00
40-100.....	44.00
110+.....	40.00
8067-082 2 Button	
10-30.....	48.00
40-100.....	46.00
110+.....	42.00
8068-082 3 Button	
10-30.....	50.00
40-100.....	48.00
110+.....	44.00

MicroClik PROXmitters with HID Tag	
8066-083 1 Button	
10-30.....	46.00
40-100.....	44.00
110+.....	40.00
8067-083 2 Button	
10-30.....	48.00
40-100.....	46.00
110+.....	42.00
8068-083 3 Button	
10-30.....	50.00
40-100.....	48.00
110+.....	44.00

MicroClik Visor Clips (Gray)	
8066-075	
1-30.....	3.30
31-100.....	2.80
101+.....	2.30

MicroPlus / MicroClik

Simple RF Control Sets

MicroPlus and MicroClik control sets consist of an RF receiver and two (2) single button transmitters packaged in a small, compact box. MicroCLIK transmitters are factory programmed to 1 of 1,000,000 available codes. MicroPLUS transmitters are programmed to 1 of 268,000,000 available codes and have a "rotating code" feature.

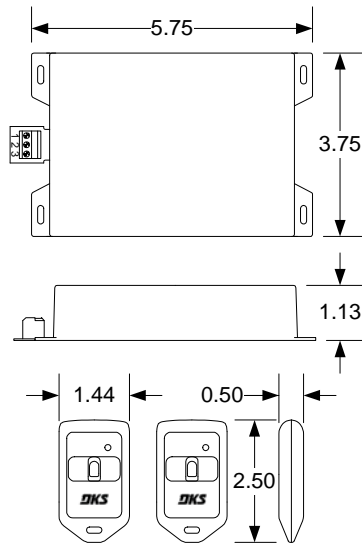

8060-081

8060-081..... 148.00

- MicroPlus RF control set
- 8055-080 MicroPlus receiver
- Stores up to 40 MicroPlus transmitter codes
- Two (2) single button (8069-080) MicroPlus transmitters
- Single pole relay

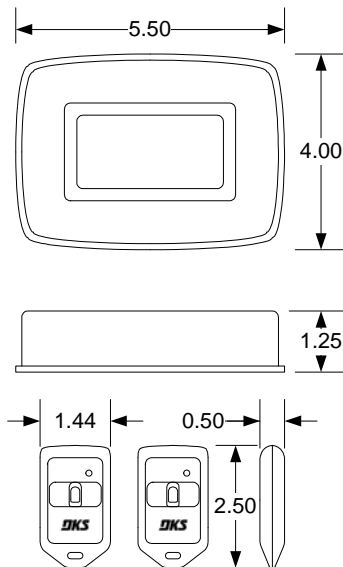

8060-080

8060-080..... 140.00

- MicroClik RF control set
- 8060-024 MegaCode receiver
- Stores up to 10 MicroClik transmitter codes
- Two (2) single button (8066-080) MicroClik transmitters
- Single pole relay

Model 1520

Single Door Controller

The model 1520 is a full feature access controller designed for single door applications. The 1520 is available in two different packages; a complete stand-alone system with a built in proximity card reader or a single door access controller that allows users to connect their own 26-bit wiegand device.

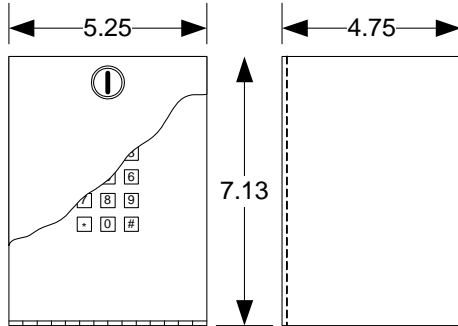

1520-081

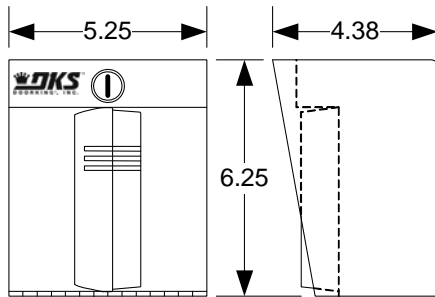

1520-080 / 1520-082 / 1520-083

Step 1: Choose Reader

1520-080 w/AWID Reader	660.00
1520-082 w/HID Reader	830.00
1520-083 w/DKS Reader	640.00
1520-081 Controller Only.....	550.00

- Includes 16 VAC power transformer
- 1520 controller only version allows for the connection of a 26-bit wiegand device.
- History buffer in the 1520 will hold up to 3656 events.
- Timed (1 – 59 minutes) anti-pass back.
- Hold open time zones.
- Printer option.

Step 2: Choose Maximum Codes Required

1520-040 125 Codes	54.00
1520-041 500 Codes	140.00
1520-042 1000 Codes	270.00

Cards

AWID Cards	Sec 4, Pg 12
HID Cards	Sec 4, Pg 14
DKS Cards	Sec 4, Pg 10

Accessories

1508-048 Printer	810.00
Mounting posts.....	Pg 11

Model 1506

Deluxe Digital Keypads

The 1506 Series provides access control for virtually any application where stand-alone digital code entry is desired. These vandal resistant keypads use stainless steel faceplates, galvanized steel sub-plates and are housed in a rugged steel cabinet. Standard style units can be surface or post mounted and flush mount units are designed to be recessed into a wall or column. The 1504 series adds an intercom sub-station that can be connected to a master intercom station.

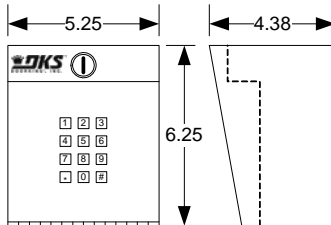

1506-08x

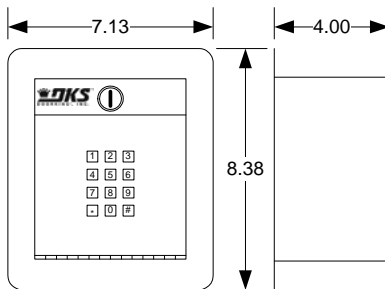

1506-09x

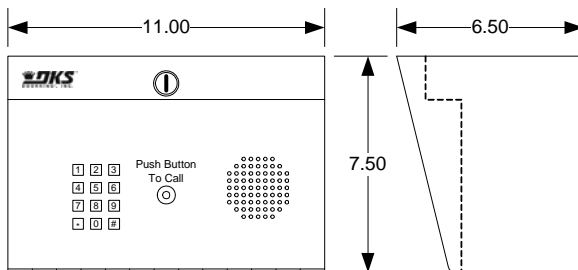

1504-08x

Surface Mount Keypads

1506-080 10 Codes	552.00
1506-082 50 Codes	632.00
1506-083 100 Codes	712.00
1506-084 250 Codes	792.00
1506-085 500 Codes	872.00
1506-086 1000 Codes	952.00

Flush Mount Keypads

1506-090 10 Codes	660.00
1506-092 50 Codes	740.00
1506-093 100 Codes	820.00
1506-094 250 Codes	900.00
1506-095 500 Codes	980.00
1506-096 1000 Codes	1060.00

Surface Mount with Intercom Substation

1504-080 10 Codes	680.00
1504-082 50 Codes	760.00
1504-083 100 Codes	840.00
1504-084 250 Codes	920.00
1504-085 500 Codes	1000.00
1504-086 1000 Codes	1080.00

- Intercom substation may not be compatible with some intercom systems.

All 1506 keypads all have these features

- Two (2) form C dry contact relays
- Time zone inputs
- Six (6) five-digit codes
- Hold codes
- Includes 16 VAC power transformer

Secondary Keypads

1506-081 Surface Mount	368.00
1506-091 Flush Mount	476.00

- Allows code activation from a second keypad. Ideal for controlled entry / exit applications.

Accessories

Mounting Posts	Pg 11
----------------------	-------

Model 1503

Basic Digital Keypads

The DKS series of basic keypads provide access control for virtually any application where stand-alone digital code entry is desired. The 1509 is designed to be mounted into a single-gang electrical box. The 1503 units can be surface or post mounted while the flush mount unit is designed to be recessed into a wall or column. The 1504 model adds an intercom sub-station that can be connected to a master intercom station.

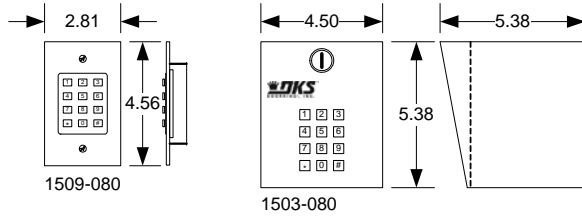

1509-080

1503-080

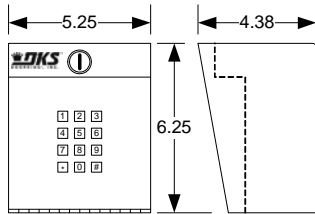

1503-081

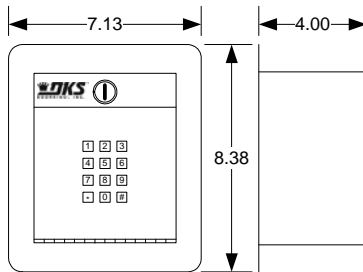

1503-082

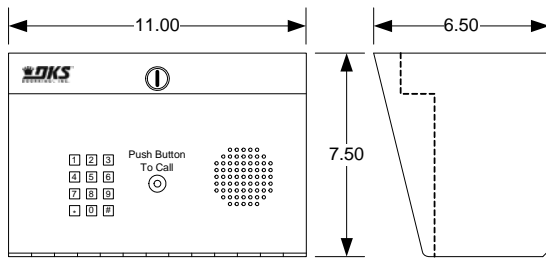

1504-081

1509-080..... 130.00

- Stores one (1) four-digit entry code and one (1) four-digit hold code
- Form C dry contact relay
- 12 – 24 Volt AC or DC power
- Mounts in single-gang electric box
- Indoor use only

1503-080 Surface Mount, not lighted 366.00

1503-081 Surface Mount, Lighted 454.00

1503-082 Flush Mount, Lighted 560.00

- Stores two (2) four-digit entry codes and one (1) four-digit hold code
- Form C dry contact relay
- 12 -24 Volt AC or DC power (Power transformer included)
- Surface mount non-lighted enclosure
- Indoor or outdoor use

1504-081..... 582.00

- Combines 1503 keypad with an intercom sub-station. Intercom substation may not be compatible with some intercom systems.
- Power transformer included

Accessories

Mounting Posts.....Pg 11

Model 1200

Key Switches

The 1200 Series provides access control for virtually any application where simple keyed entry control is desired. These vandal resistant key switches use stainless steel faceplates and are housed in a rugged steel cabinet. The 1209 adds an intercom sub-station that can be connected to a master intercom station.

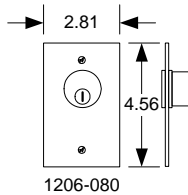

1206-080

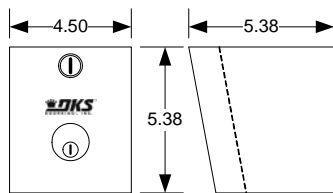

1207-080

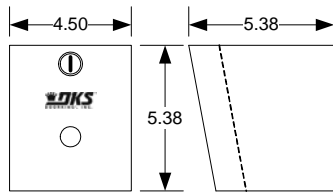

1210-080

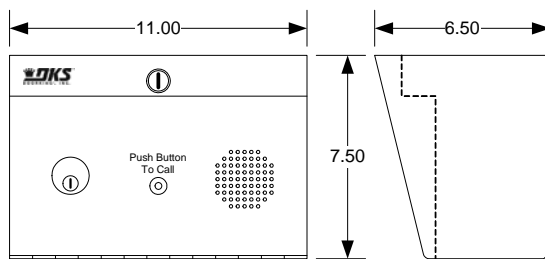

1209-080

1206-080..... 82.50

- Mortise key cylinder
- Switch can be set for Normally Open (N.O.) or Normally Closed (N.C.)
- Mounts in single-gang electric box
- Indoor use only

1207-080..... 216.00

- Mortise key cylinder
- Switch can be set for Normally Open (N.O.) or Normally Closed (N.C.)
- Surface mount non-lighted enclosure
- Indoor or outdoor use

1210-080..... 216.00

- Ace key cylinder
- Normally Open (N.O.) only
- Surface mount non-lighted enclosure
- Indoor or outdoor use

1209-080..... 368.00

- Mortise key cylinder
- Switch can be set for Normally Open (N.O.) or Normally Closed (N.C.)
- Surface mount lighted enclosure
- Indoor or outdoor use
- Intercom sub-station may not be compatible with some intercom systems

Accessories

Mounting Posts.....Pg 11

Mounting Posts

Standard Mounting Posts

Standard mounting posts are designed for pad mounting or can be mounted using an in-ground adapter. All posts include a base plate and base plate cover.

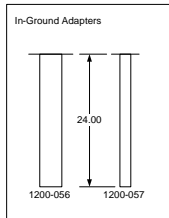
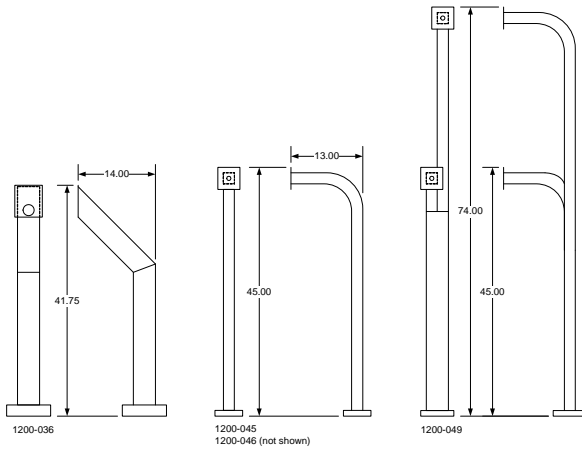

Heavy-Duty Post

1200-036 Offset Pad Mount Small ????.00

- This post is constructed from 4" x 4" steel stock and have a 8" x 8" base plate
- In-ground adapter provides a mount for posts with base plates

Standard Posts

1200-045 Pad Mount 214.00
 1200-046 In-Ground Mount..... 214.00
 1200-049 Dual Height 422.00
 1200-057 In-Ground Adapter..... 190.00

- These posts are constructed from 2" x 2" steel stock and have a 5" x 5" base plate
- In-ground adapter provides a mount for posts with base plates
- In-ground mount posts do not have a base plate and extend an additional 24 inches in length

Lock Boxes

Postal and Fire Department

Postal and Fire Department lock boxes provide a method for these authorities to gain access through a controlled access point.

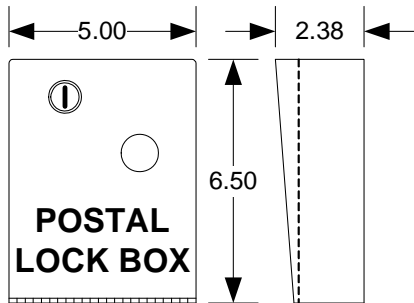

1402-080

1402-080..... 99.50

- Accepts standard postal key lock
- Postal lock can be installed to either open the 1402 box, or activate a door or gate
- Surface or post mount
- Painted postal blue

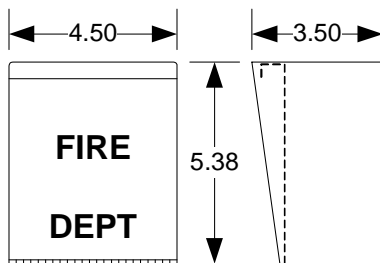

1400-080

1400-080..... 99.50

- Accepts Fire Department pad lock
- Cover opens and activates a switch when the pad lock is removed
- Gate or door will hold open until the cover is closed and the pad lock replaced
- Surface or post mount
- Painted bright red

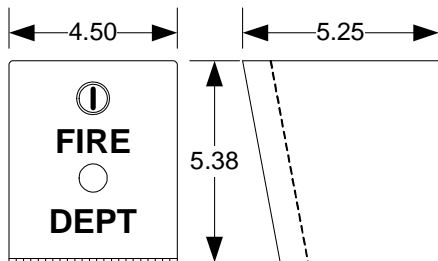

1401-080

1401-080..... 99.50

- Accepts Knox 3501 key switch
- Surface or post mount
- Faceplate painted bright red, box is painted black

Exit Push Buttons

Standard & Piezoelectric Switches

These push buttons are typically used as “request to exit” devices in access control applications. They can be installed in a single-gang electric box or can be mullion mounted.

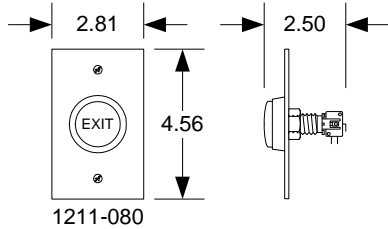

1211-080..... 52.00

- Stainless steel faceplate
- Requires 12-volt AC or DC power to illuminate exit button
- Mounts into a single-gang electric box

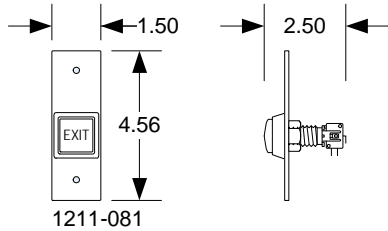

1211-081..... 48.00

- Stainless steel faceplate
- Requires 12-volt AC or DC power to illuminate exit button
- Mullion mount

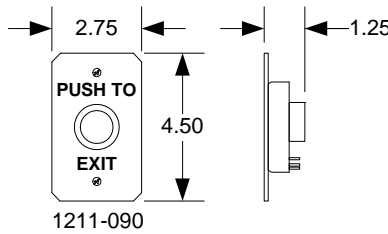

1211-090..... 298.00

- Vandal resistant stainless steel faceplate and button cap
- Piezoelectric switch
- Selectable illumination status (red, green)
- Requires 12 to 24 Volt DC power
- Mounts into a single-gang electric box

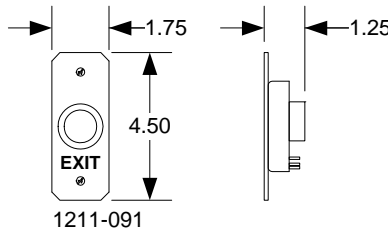

1211-091..... 298.00

- Vandal resistant stainless steel faceplate and button cap
- Piezoelectric switch
- Selectable illumination status (red, green)
- Requires 12 to 24 Volt DC power
- Mullion mount

Accessories

Time Clock & Surge Suppressers

Electronic time clocks are ideal for use in applications where an access control system does not control "hold open" time periods. Surge suppressers are designed to provide additional protection to equipment in areas prone to voltage spikes and surges. Surge suppressers come with a plastic mounting bracket.

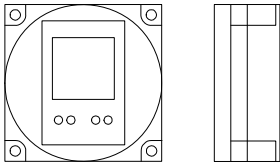

2600-791

2600-791..... 205.50

- 7 Day Time Clock
- 20 programs
- 24 Volt AC input power
- Form "C" dry contact relay

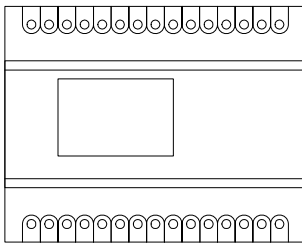

2600-795

2600-795..... 640.00

- 365 Day Time Clock
- 7-Day and 24 hour programming features
- Holiday programming
- Automatic leap-year adjustment through 2095
- Daylight savings time
- 24 Volt AC input power

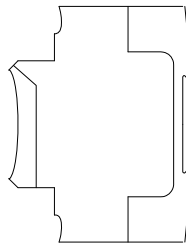

1876-010..... 124.00

- High Voltage (110-120 VAC)

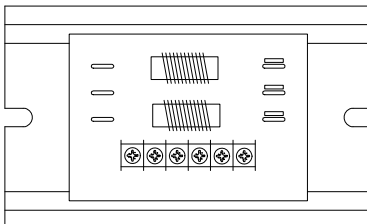

1876-010 / 1877-010 / 1878-010

1877-010..... 124.00

- Phone Line

1878-010..... 124.00

- Low Voltage (24-20 VAC)

Accessory Transformers

12, 16, 24 Volt AC & DC Transformers

A variety of accessory transformers are available to power the different products that we sell. AC transformers are typically used with access control devices and controllers, while DC transformers are used with magnetic locks and proximity card readers. Check the individual product to determine which transformer is required. NOTE: Many of our products INCLUDE a transformer.

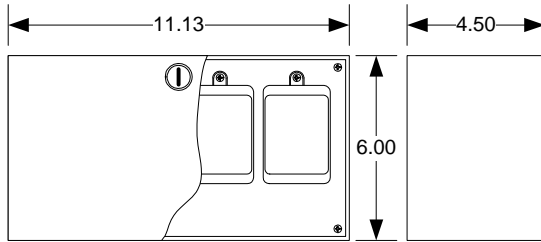

1200-080

Transformer Box

1200-080..... 130.00

- Holds up to four (4) 20-VA transformers
- Suitable for indoor and outdoor use
- Does not include transformers

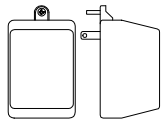

20 VA Transformers

1215-061 12-Volt AC Output
 1804-059 24-Volt AC Output
 1804-060 16-Volt AC Output

20-VA Transformers

1215-061 12-Volt, AC..... 37.50
 1804-059 24-Volt, AC..... 43.50
 1804-060 16-Volt, AC..... 43.50

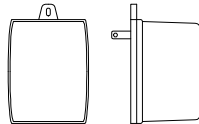

50 VA Transformer

1508-060 16-Volt AC Output

50-VA Transformer

1508-060 16-Volt, AC..... 48.00

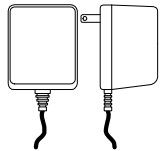

DC Transformers

1215-060 24-Volt 350 mA
 1812-035 24-Volt 500 mA
 1812-037 12-Volt 1000 mA

DC Transformers

1215-060 24-Volt, 350 ma 43.50
 1812-035 24-Volt, 500 ma 32.50
 1812-037 12-Volt, 1000 ma 39.00

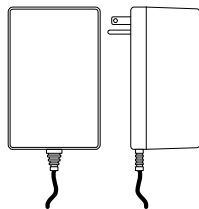

Regulated DC Transformer

1812-038 12-Volt 1000 mA

DC Regulated Transformer

1812-038 12-Volt, 1000 ma 97.50

Replacement Components

Circuit Boards	
1500-010	240.00
Use with 1503, 1504-081 only	
1505-009	430.00
Use with 1520 only - memory chip not included	
1506-010	408.00
Use with 1506, 1504 only – memory chip not included	
8054-010	324.00
Use with 8054 only	
8055-010	108.00
Use with 8055 only	
8056-010	162.00
Use with 8056 only	
8057-010	172.00
Use with 8057 only	
8059-010	108.00
Use with 8059 only	
1587-010	66.00
Printer interface board	

Keypads	
1895-019.....	106.00
Use with 1503, 1504, 1506 and secondary keypads	
8057-030.....	54.00
Use with 8054 and 8057 receivers	
1597-010.....	84.00
Secondary keypad interface board	
1599-010.....	162.00
Secondary keypad interface board, 1504 and 1506	

LED Light Kits	
1804-701.....	20.00
Use with 1209, 1506, 1504 w/1506 keypad	
1804-706.....	20.00
Use with 1503, 1504 w/1503 keypad	

