

HEATER WITH FAN ASSEMBLY KIT

DoorKing Part Numbers
1601-154, 9210-154
 Transformer

This kit is designed for models 6050, 6100, 6300, 9000s, 9100s, 9200s, and 9530 model gate operators. For climates where temperatures routinely drop below 40°F (4°C). An automatic thermostat will control temperature inside operator housing.

Kits Include: Kit #1601-154: Heater with mounting plate.
 Kit #9210-154: Replacement transformer, 4 carriage bolts and nuts, heater with mounting plate.

Installation

- 1 Shut off AC power to operator.
 Turn off DC power switch on certain models.

2 Heater Location

Determine heater's mounting location.

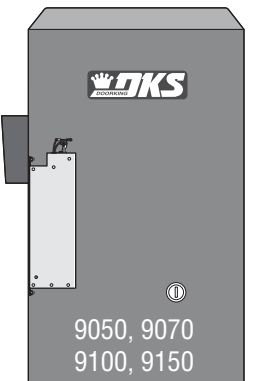
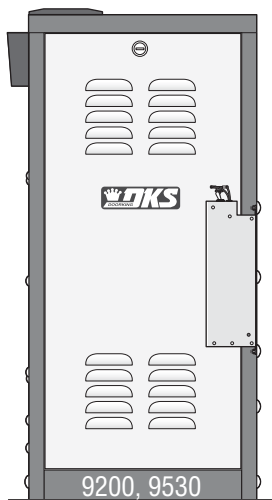
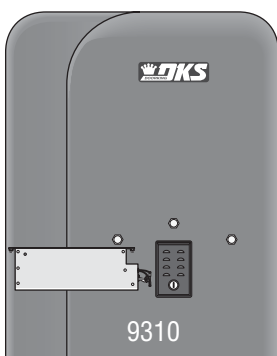
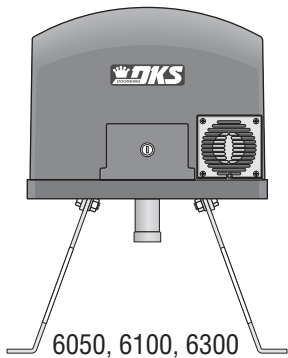

3 Mounting Heater

Locate existing threaded studs and nuts in operator. Heater **must** mount on mounting plate.

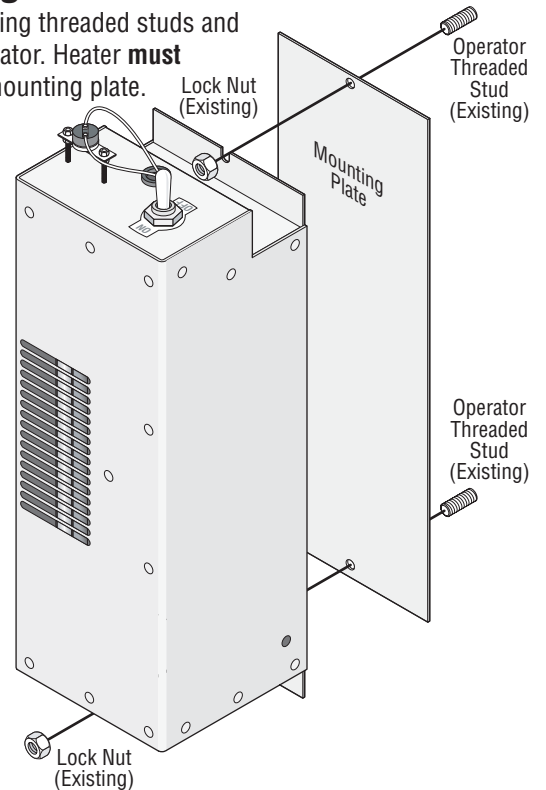

4 Power Connection

Connect the heater power wires according to operator model type.

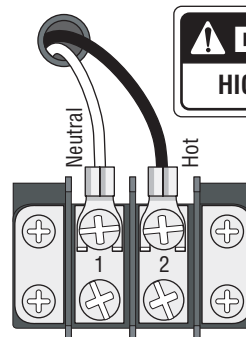

115 VAC Models

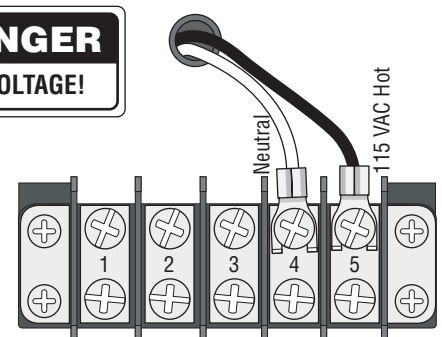

208/230/460 VAC Models

⚠ Note: Models 9200s and 9530 with 208/230/460 VAC must have their step-down transformer replaced for the heater to function. See back page.

5 Heater Switch



ON - Normal setting. Automatically turns the heater and fan **ON** when the temperature drops below 40°F (4°C) inside the operator, and turns the heater and fan **OFF** when the temperature rises above 55°F (13°C) inside the operator.

OFF - Turns the heater off.



HEATER WITH FAN ASSEMBLY KIT

DoorKing Part Numbers
1601-154, 9210-154
Transformer

Replacement of Step-Down Transformer

Models 9200s and 9530 with 208/230/460 VAC will require replacement of existing step-down transformer with a new transformer to handle the extra power draw of the heater (Kit #9210-154). This will fit in the same area and wire the same as the existing transformer.

DO NOT install the heater in these operators without installing the replacement transformer.

- 1 Shut off AC power to operator.
Turn off DC power switch on certain models.



- 2 Remove existing transformer from back of hinged electronics box.
Note wire positions when disconnecting.

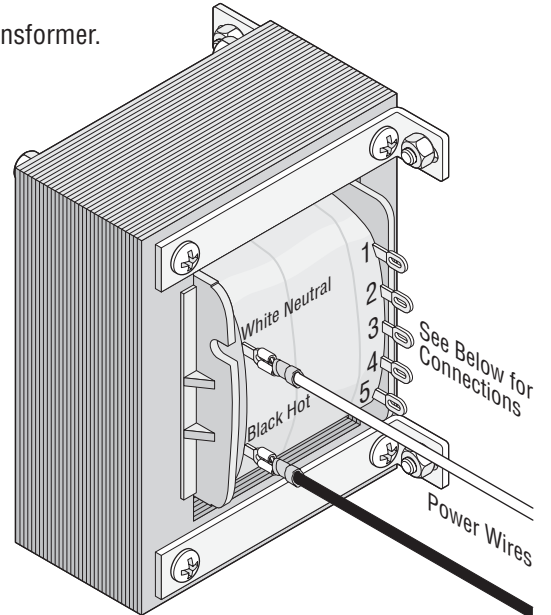
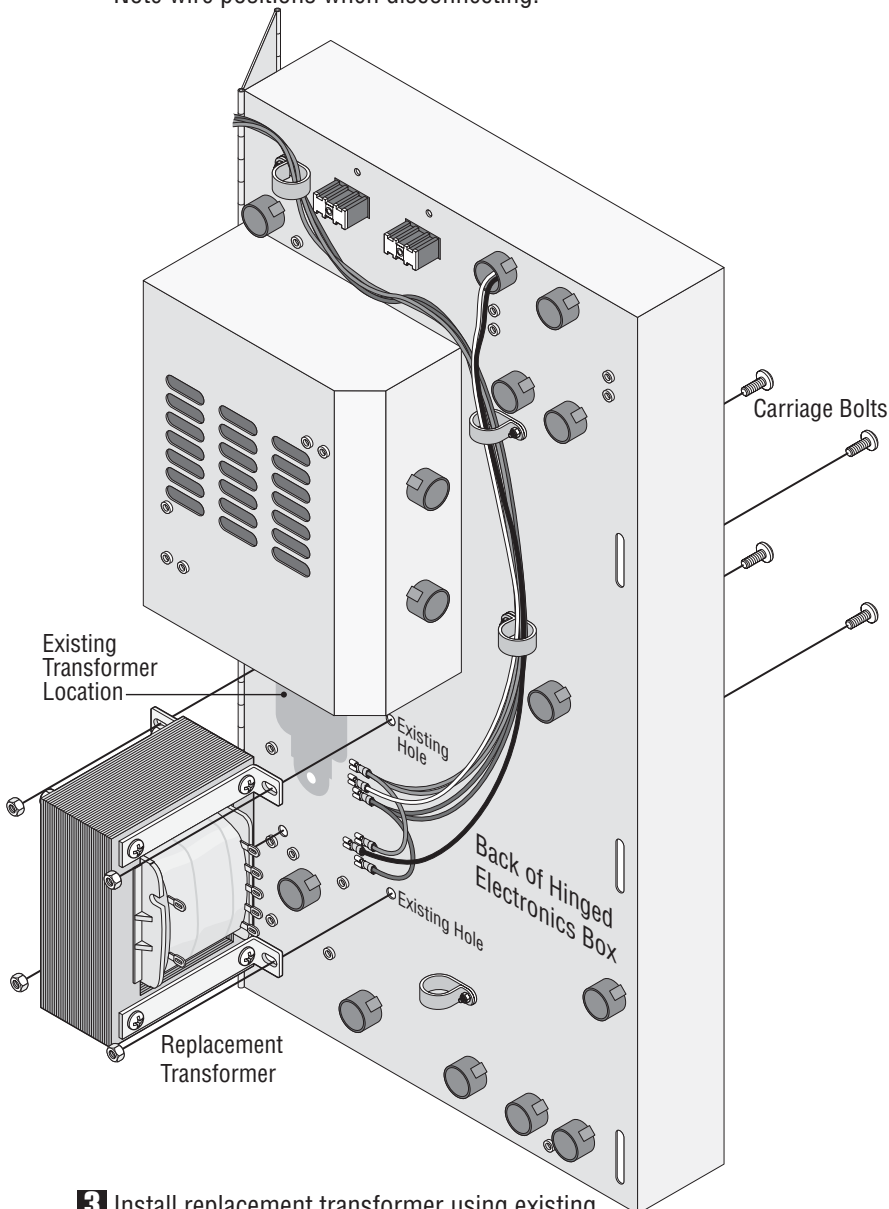

- 4 Reconnect wires to replacement transformer in the same positions as the old transformer.

208 VAC

Phase 1 and 3
Red 1
Blue 2
Black 3
Red 4
Black 5

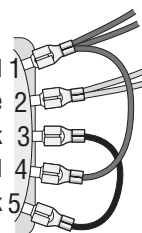

Phase 1 and 3
Variable Speed
Blue 1
Red 2
Black 3
Blue 4
Black 5

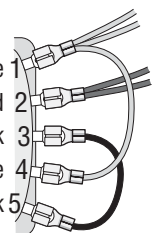

230 VAC

Phase 1 and 3
Red 1
Open 2
Blue 3
Red 4
Blue 5

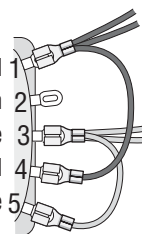

Phase 1 and 3
Variable Speed
Blue 1
Open 2
Red 3
Blue 4
Red 5

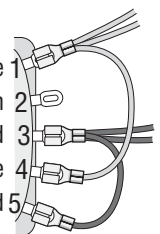

460 VAC

Phase 3
Red 1
Open 2
Black 3
Black 4
Blue 5

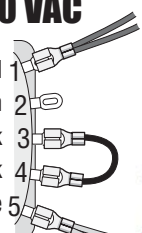

- 3 Install replacement transformer using existing holes in electronics box with supplied carriage bolts. Note: Circuit and loop boards must be removed for carriage bolt installation.



120 Glasgow Avenue
Inglewood, California 90301 U.S.A.