



Owner's Manual

***Model 1808 and 1810 Access Plus Systems
PC Programmable Telephone Entry / Access Control System***

DoorKing, Inc.
120 Glasgow Avenue
Inglewood, California 90301
U.S.A.
Phone: 310-645-0023
Fax: 310-641-1586
www.doorking.com

Use this manual with the following models only.

1808 and 1810 Access Plus Telephone Entry / Access Control Systems with circuit board 1970-010.

DoorKing, Inc. reserves the right to make changes in the products described in this manual without notice and without obligation of DoorKing, Inc. to notify any persons of any such revisions or changes. Additionally, DoorKing, Inc. makes no representations or warranties with respect to this manual. This manual is copyrighted, all rights reserved. No portion of this manual may be copied, reproduced, translated, or reduced to any electronic medium without prior written consent from DoorKing, Inc.

Table of Contents

Preface

Important Notices.....	6
General Information.....	7
Features	8

Section 1 – Installation & Wiring

Installation Guidelines	
1.1	Mount the Access Plus Unit.....9
1.2	Dimensions
	Surface Mount 181010
	Surface Mount Recess Box 1810.....11
	Flush Mount Model 1810.....12
	Flush Mount Rough-In Box 1810.....13
	Flush Mount Trim Kit 181014
	Surface Mount Trim Ring for Flush Mount Unit 1810.....15
	Surface Mount 180816
	Postal switch Installation17
1.3	Power Wiring19
1.4	Auto-Dialer Wiring Diagram – Single Unit20
1.5	Auto-Dialer Wiring Diagram – Multiple Units21
1.6	Telephone Intercom Wiring with 1816 AP Module22
1.7	1816 Access Plus Detail Wiring.....23
1.8	Main Terminal Description.....24
1.9	Access Plus Interface Board
	1.9.1 RS-485 Wiring26
	1.9.2 Network Connections28
	1.9.3 Modem Connections31

Section 2 – Programming

2.1	Programming the Master Code32
2.2	Programming Methods33
2.3	Programming with a Computer
	2.3.1 Enable / Disable TCP / IP Support – System Reboot34
	2.3.2 Set the IP Address34
	2.3.3 Sub-Net Mask.....35
	2.3.4 Set the Gateway (router) IP Address35
	2.3.5 Set the Port Number.....35
2.4	System Parameters – Programming via Keypad / Touch-Tone telephone36
	Programming Reference Table37
	2.4.1 Single or Multiple Units.....38
	2.4.2 Single or Double Ring38
	2.4.3 Number of Rings to Residence39
	2.4.4 Talk Time.....39
	2.4.5 Relay Strike Time.....39
	2.4.6 Tone Open Numbers.....40
	2.4.7 Answer Incoming Calls on X Rings40
	2.4.8 Hang Up Tone41
	2.4.9 Call Waiting41
	2.4.10 Turn Speaker On.....41
	2.4.11 Set Microphone Gain and Speaker Volume42

2.5	Directory Codes	
2.5.1	Directory Codes 24 – 50 Dial Phone Number	43
2.5.2	Delete Phone Number from Directory Codes 24 - 50	43
2.5.3	Delete All Phone Numbers from Directory Codes 24 - 50.....	43
2.6	Devices	
2.6.1	Simple Access Code Programming	44
2.6.2	Number of RS-485 Devices	44
2.6.3	Additional Relay Off-line Function.....	44
2.6.4	Device Access Code Programming	45
2.6.5	Delete Device Access Codes.....	45
2.6.6	Delete All Device Access Codes.....	45
2.6.7	Temporary Device Access Code programming	46
2.6.8	Delete Temporary Device Access Codes	46
2.4.9	Delete All Temporary Device Access Codes	46
2.7	Time Functions	
2.7.1	Program the Calendar Chip	47
2.7.2	Relay Hold Schedule.....	48
2.7.3	Time Zones	49
2.8	Miscellaneous	
2.8.1	Restore Defaults	50
2.8.2	Erase Transaction Log	50

Section 3 – Adjustments

Speaker Volume and Microphone Gain.....	51
Interface Board LED Status	52

Section 4 – User Instructions

4.1	Resident Operating Instructions	
4.1.1	Granting or Denying a Guest Access.....	53
4.1.2	Call Waiting	53
4.1.3	Dial-Connect (using 1816 AP module).....	54
4.1.4	Dial-Out Phone Numbers.....	54
4.1.5	Access Codes	54
4.2	Remote Operation	
4.2.1	Remote Programming	55
4.2.2	Remote Relay Activation.....	55
4.2.3	Relay Activation Check	56

Section 5 – Maintenance and Trouble Shooting

5.1	Trouble Shooting	57
5.2	Trouble Shooting Tables	58
5.3	Internal Wire Diagram	59
5.4	Accessories	60
5.5	Programming Information Tables.....	61
	Directory Codes / Dial-Out Phone Numbers	62
	Access Code Log Sheet	64

Important Notices

FCC – United States

This equipment has been tested and found to comply with the limits for a class A digital device, pursuant to Part 15 of the FCC Rules and Regulations. These limits are designed to provide reasonable protection against harmful interference when the equipment is operated in a commercial environment. This equipment generates, uses, and can radiate radio frequency energy and, if not installed and used in accordance with the instruction manual, may cause harmful interference to radio communications. Operation of this equipment in a residential area is likely to cause harmful interference in which case the user will be required to correct the interference at his own expense.

FCC Registration Number: **DUF6VT-12874-OT-T**

DOC - Canada

The Canadian Department of Communications label identifies certified equipment. This certification means that the equipment meets certain telecommunications network protective, operational, and safety requirements. The Department does not guarantee the equipment will operate to the users satisfaction.

Before installing this equipment, users should ensure that it is permissible to be connected to the facilities of the local telecommunications company. The equipment must also be installed using an acceptable means of connection. The customer should be aware that compliance with the above conditions may not prevent degradation of service in some situations.

Repairs to certified equipment should be made by an authorized Canadian maintenance facility designated by the supplier. Any repairs or alterations made by the user to this equipment, or equipment malfunctions, may give the telecommunications company cause to request the user to disconnect the equipment.

Users should ensure, for their own protection, that the electrical ground connections of the power utility, telephone lines, and internal metallic water pipe system, if present, are connected together. This precaution may be particularly important in rural areas.

CAUTION: Users should not attempt to make such connections themselves, but should contact the appropriate electric inspection authority, or electrician, as appropriate.

DOC Registration Number: **1736 4507 A**

Notice:

The Load Number (LN) assigned to each terminal device denotes the percentage of the total load to be connected to a telephone loop which is used by the device, to prevent overloading. The termination on a loop may consist of any combination of devices subject only to the requirement that the sum of the load numbers of all the devices does not exceed 100.

Notice:

DoorKing does not provide a power transformer on units sold into Canada. Use only transformers that are CSA listed to power the telephone entry system. The model 1812-Plus requires a 16-volt, 20 VA transformer.

General Information

- Prior to beginning the installation of the telephone entry system, we suggest that you become familiar with the instructions, illustrations, and wiring guidelines in this manual. This will help insure that your installation is performed in an efficient and professional manner.
- The proper installation of the telephone entry panel is an extremely important and integral part of the overall access control system. Check all local building ordinances and building codes prior to installing this system. Be sure your installation is in compliance with local codes.
- When used to control a door or pedestrian gate, try to locate the telephone entry system as near as possible to the entry point. The unit should be mounted on a rigid wall to prevent excessive shock and vibration from closing doors or gates. Continuous vibration and shock from slamming doors or spring-loaded pedestrian gates will damage the circuit board. **Under no circumstances should the unit be mounted directly to a moving door or gate.**
- **ADA mounting requirements for door control.** The requirements below apply only when the telephone entry system is being used to control entry through a public door only. If this system is used to control entry through a vehicular gate or private entrance, the dimensions noted below do not apply.
 1. If the clear floor space allows only forward approach to the system, the maximum high forward reach allowed is 48 inches above grade to the top of the keypad.
 2. If the high forward reach to the system is over an obstruction of greater than 20 inches but less than 25 inches, the maximum high forward reach allowed is 44 inches above grade to the top of the keypad.
 3. If the clear floor space allows parallel approach by a person in a wheelchair, the maximum high side reach shall be 54 inches above grade to the top of the keypad.
 4. If the high side reach is over an obstruction of 24 inches or less, the maximum high side reach allowed is 46 inches above grade to the top of the keypad.
- **When used to control a vehicular gate with an automatic gate operator, the telephone entry system must be mounted a minimum of six (6) feet away from the gate and gate operator, or in such a way that a person cannot operate the entry system and/or touch the gate or gate operator at the same time.**
- Be sure that the system is installed so that it is not directly in the traffic lane. Goose neck mounting post and kiosks work well for these type systems. When planning where to locate the system, take into consideration traffic lane layouts, turn around lanes for rejected access, conduit runs, power availability, etc.
- Environmental factors must also be taken into account. Surface mount units are designed for direct outdoor installations, however it is preferable to protect them from direct exposure to driven rain or snow whenever possible. Flush mount units must be protected from direct exposure to the elements.
- This telephone entry system contains a number of static sensitive components that can be damaged or destroyed by static discharges during installation or use. Discharge any static prior to removing the circuit board from the lobby panel by touching a proper ground device.
- **Instruct the end user to read and follow these instructions. Instruct the end user to never let children play with or operate any access control device. This Owner's Manual is the property of the end user and must be left with them when installation is complete.**

Features

- IP Addressable – program from your PC using the DoorKing programming software via a LAN or WAN connection, or via a built-in modem.
- When internet connection is provided, system can send e-mail notification on 58 selectable events and 20 access codes.
- Two internal relays allow the system to control a main entry gate plus a pedestrian access gate.
- Control up to six (6) additional entry points with card readers, keypads or wireless RF via RS-485 connection.
- 100 card / transmitter / keypad codes when programming from the software application.
- Holiday schedule.
- 500 event transaction buffer.
- Unique distinctive ring (when interfaced with the 1816 Access Plus telephone intercom).
- Unit connects directly to the tenant's existing telephone line. No additional monthly expense for a second telephone line (when interfaced with the 1816 Access Plus telephone intercom).
- Built in call waiting assures that incoming calls or guest calls are not missed (when interfaced with the 1816 Access Plus telephone intercom).
- Up to 27 preprogrammed dial-out telephone numbers + 23 intercom mode phone lines (when interfaced with the 1816 Access Plus telephone intercom).
- Built-in clock / calendar.
- Four hold-open time zones.
- Entry code time zones.
- 10 temporary access codes.
- Unit can be programmed to work with PBX and KSU phone systems.
- Optional secondary keypad can be added for remote entry code activation of door or gate. Order part number 1812-082.

SECTION 1 - INSTALLATION

Installation of the Access Plus Telephone Entry and Access Control System involves the installation of the hardware and the wiring of these components.



If used to control a vehicular gate with an automatic gate operator, the telephone entry system must be mounted a minimum of six (6) feet away from the gate and gate operator, or in such a way that a person cannot operate the entry system and/or touch the gate or gate operator at the same time.

1.1 Mount the Access Plus Unit

Surface mount units can be mounted directly to a wall or pilaster or post mounted using a DoorKing mounting post (there are several different styles available). Flush mount units are designed to be mounted into a pilaster, wall or kiosk. In any case, be sure that the unit is securely mounted and is not subject to continuous vibration from closing doors or gates.

1. Open the cabinet and carefully disconnect the front panel terminal connector and the keypad connector. The front panel terminal connector is located in the lower right hand corner. The entire connector will come off the board by gently pulling it straight out.
2. Remove four (4) 6-32 x 1/2 round head screws from each corner of the control board.
3. Remove the control board from the housing. CAUTION: The control board contains static sensitive components. Discharge any static electricity from your hands by touching a proper ground device before removing the control board.
4. Mount the housing assembly. Make any conduit connections at this time. Be sure that the mounting screws do not protrude into the cabinet where they could cause a short.
5. Route wiring into the housing assembly at this time. DO NOT APPLY POWER.
6. Clean out the back box. Be sure that all dirt, metal or wood debris is removed from the back box.
7. Remove the main terminal wiring connector from the control board by gently pulling it straight up. This will make wiring to the main terminal easier.
8. Install the control board into the back box. Secure the control board with the four (4) 6-32 x 1/2 screws removed in step 2. CAUTION: The control board contains static sensitive components. Discharge any static electricity from your hands by touching a proper ground device before installing the control board.
9. Plug the front panel connector onto the control board pins in the lower right hand corner. The red wire goes to the left.
10. Plug the keypad connector onto the circuit board plug. The cable points down.
11. After pre-wiring the main terminal control board connector (see wiring instructions), carefully re-install it onto the control board main terminal pins.

1.2 Dimensions

Surface Mount 1810 Access Plus

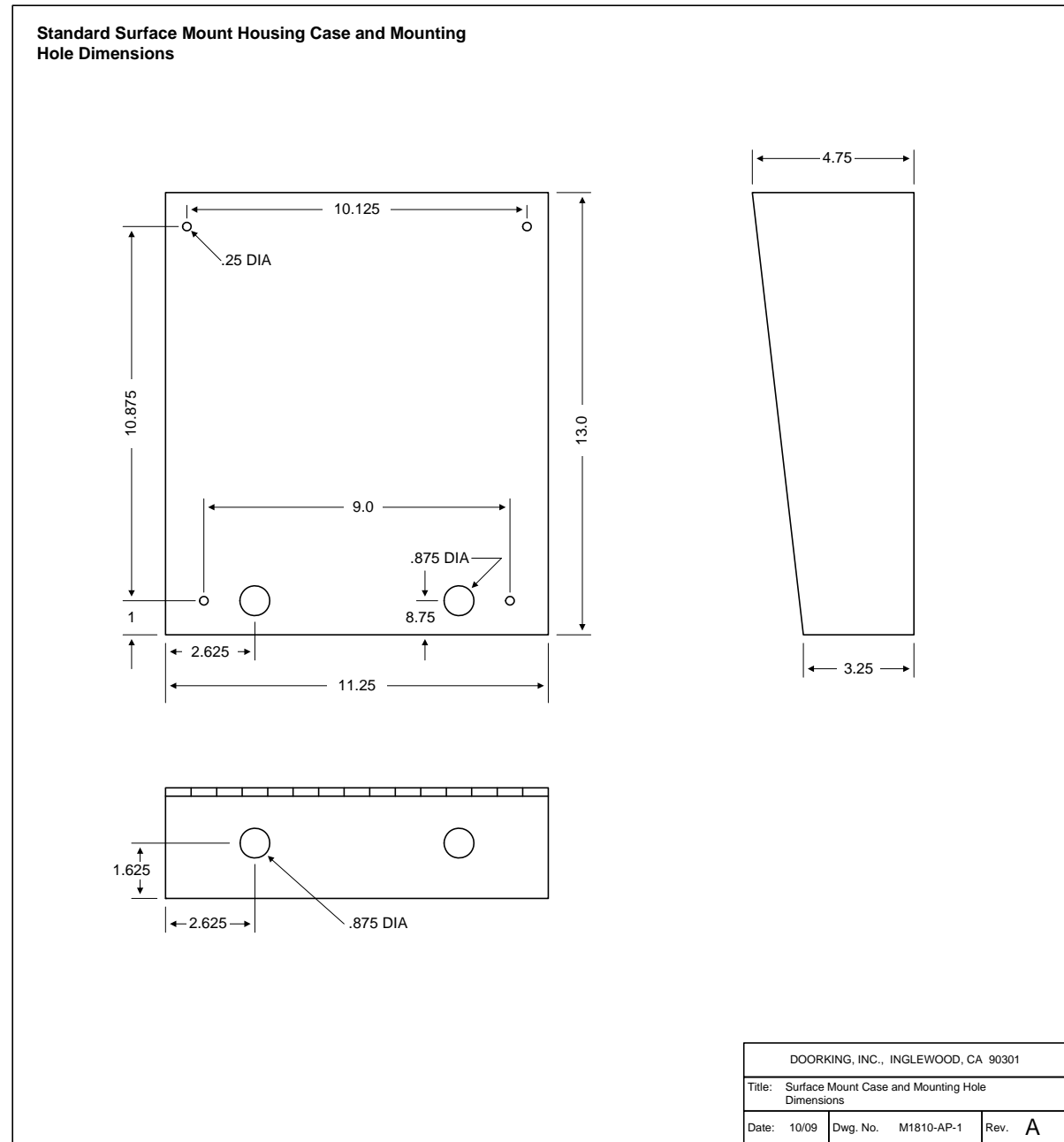

Surface Mount 1810 Access Plus with Recess Box/Trim Ring

Standard Surface Mount Recess Mounting Box (P/N 1803-150)

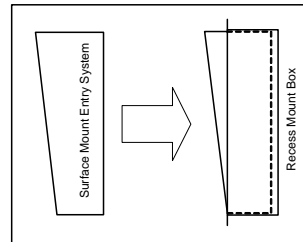
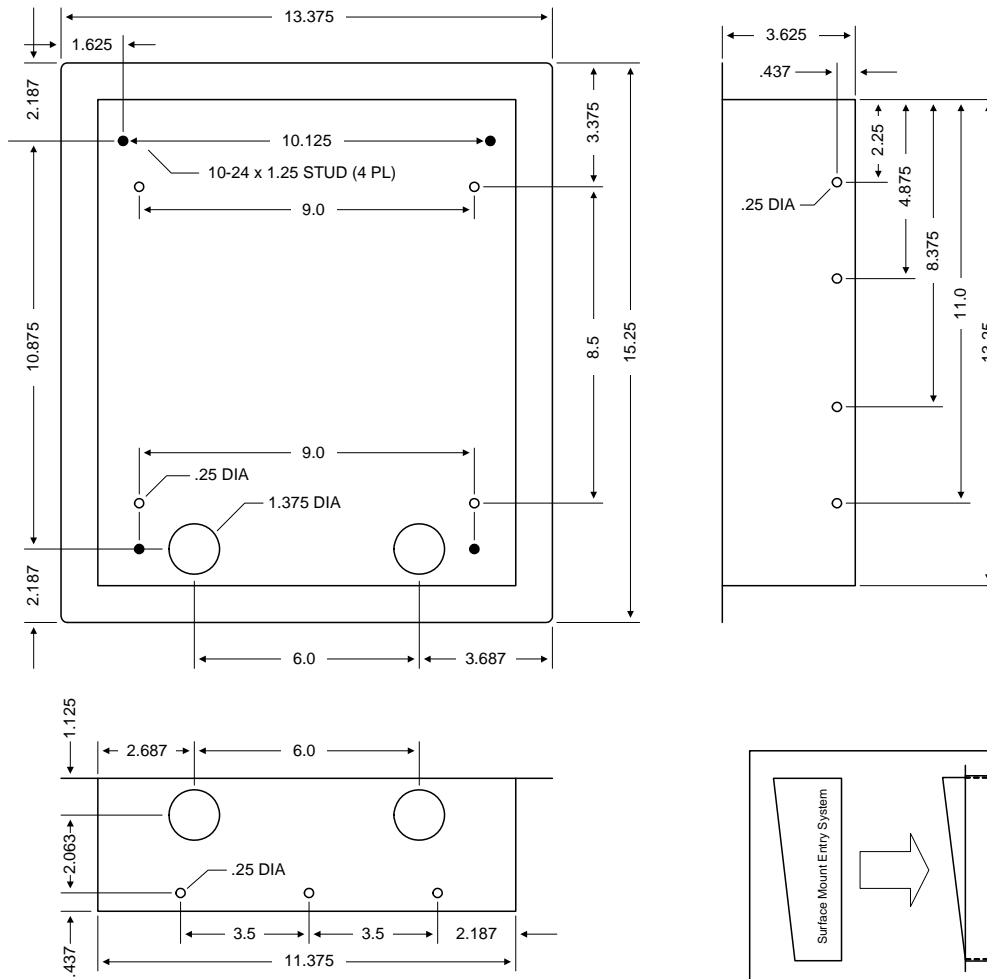

DOORKING, INC., INGLEWOOD, CA 90301		
Title: Surface Mount Recess Mounting Box		
Date: 11/09	Dwg. No. M1800-065-2	Rev. C

Flush Mount 1810 Access Plus

Flush Mount Units

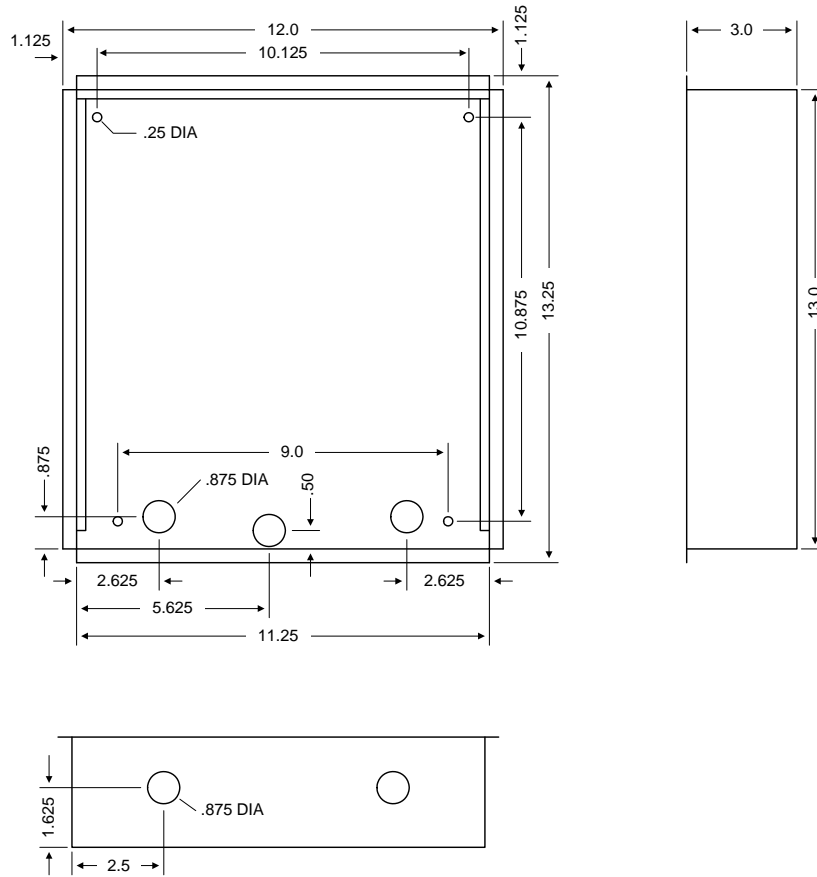

DOORKING, INC., INGLEWOOD, CA 90301			
Title: Flush Mount Units			
Date: 10/05	Dwg. No. M1800-065-3	Rev. B	

Flush Mount Rough-in Box (1810 Access Plus only)

Flush Mount Rough-in Box

(Flush mount rough-in box is included with the 1814-165 and 1814-166 flush mount kits)

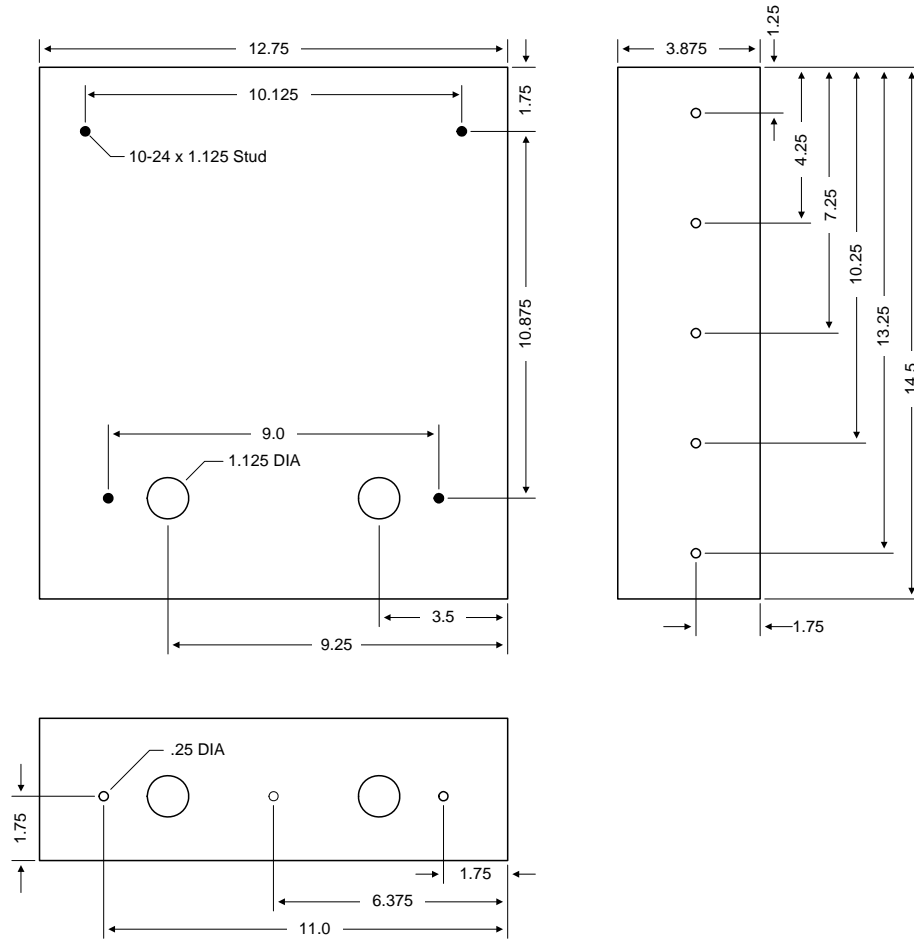

DOORKING, INC., INGLEWOOD, CA 90301		
Title: Flush Mount Rough-in Box		
Date: 11/09	Dwg. No. M1800-065-4	Rev. C

Flush Mount Trim Ring (1810 Access Plus only)

Flush Mount Kit (P/N 1814-165 and 1814-166)

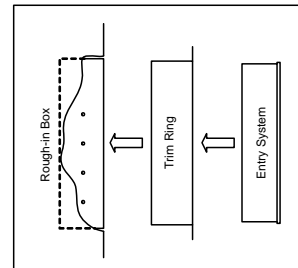
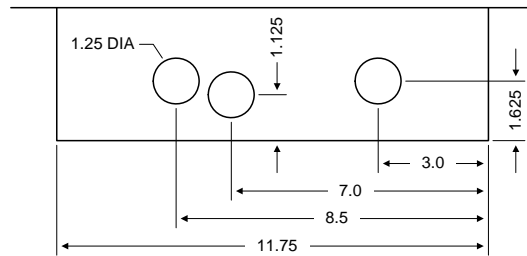
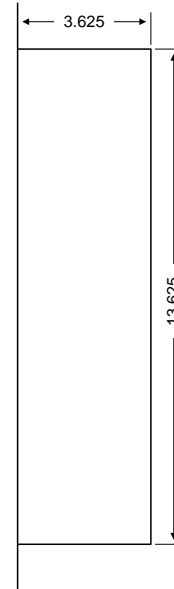
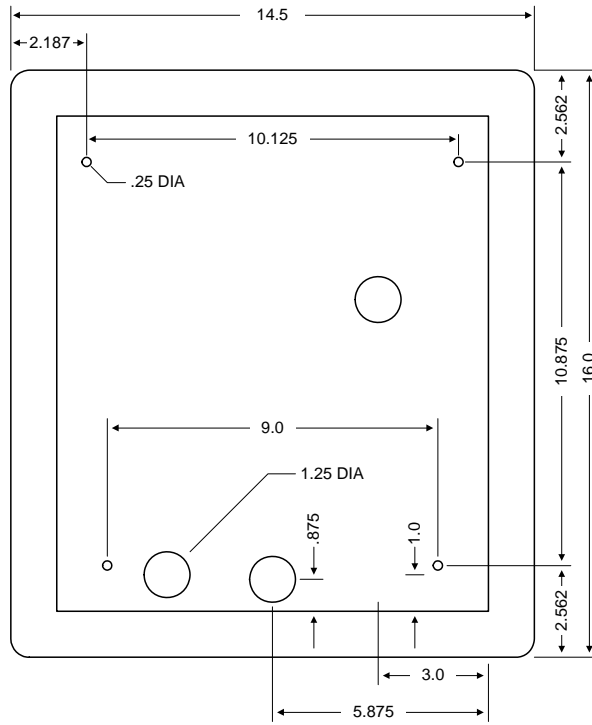

DOORKING, INC., INGLEWOOD, CA 90301

Title: Flush Mount Kit

Date: 11/09 Dwg. No. M1800-065-5 Rev. C

Surface Mount Trim Ring for Flush Mount Units (1810 Access Plus only)

Surface Mounting Kit for Flush Style Units (P/N 1814-152)

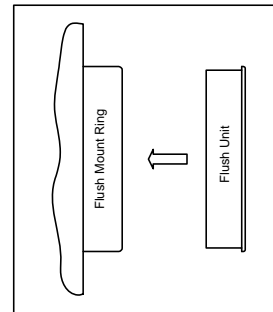
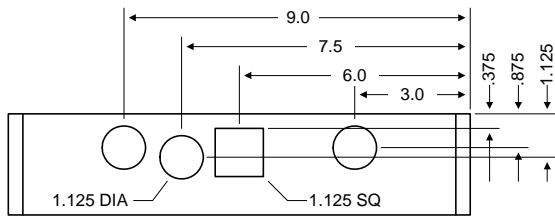
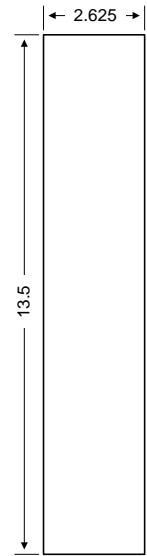
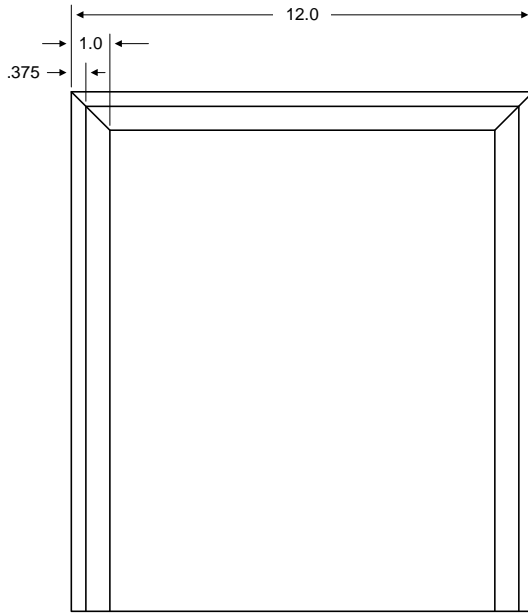

DOORRING, INC., INGLEWOOD, CA 90301			
Title: Surface Mount Kit for Flush Style Units			
Date: 11/09	Dwg. No. M1800-065-6	Rev. B	

Surface Mount 1808 Access Plus

1808 Surface Mount Housing

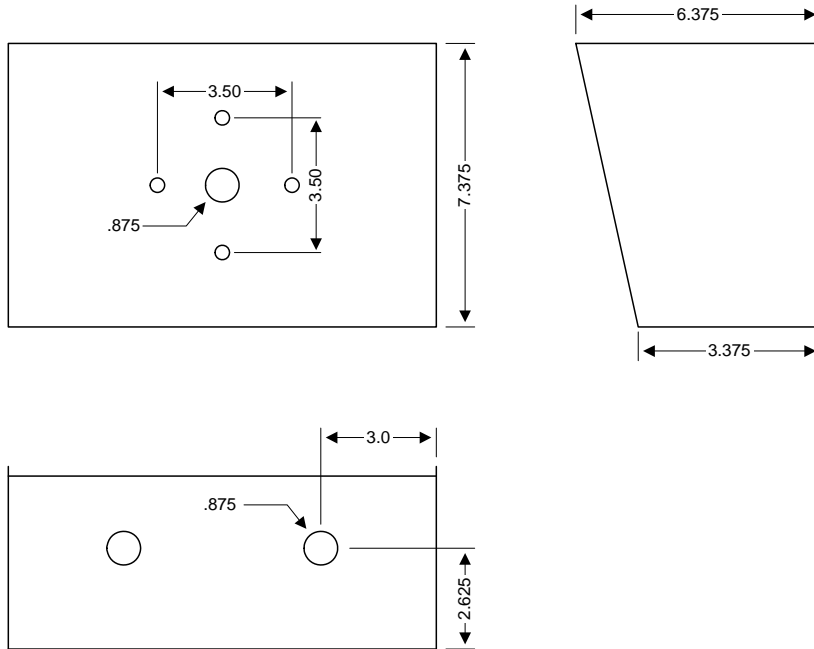

DOORKING, INC., INGLEWOOD, CA 90301		
Title: 1808 Surface Mount Case		
Date: 9/03	Dwg. No. M1800-065-10	Rev. A

Postal Switch Installation (1810 Access Plus only)

The 1808 Access Plus unit does not have provisions for the installation of the postal switch. If letter carrier access is required when using the 1808, the postal switch can be mounted in the DoorKing P/N 1402-080 - Postal Lock Box.

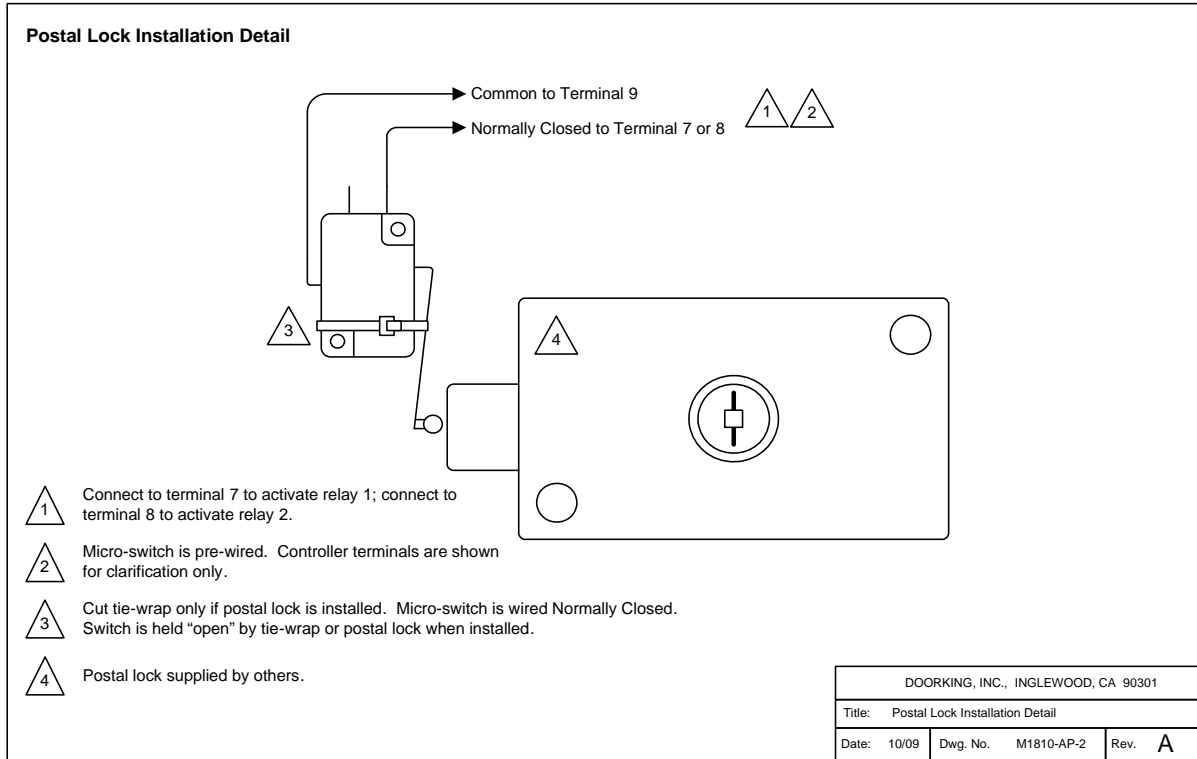

1.3 Power Wiring

Do not run telephone lines / data lines and high voltage lines in the same conduit. Separate high voltage and telephone / data line conduits by at least six (6) inches.

POWER WIRING	
WIRE SIZE	MAX DISTANCE IN FEET
18 AWG	100
16 AWG	200

Access Plus Units operate on 16.5 VAC. Do not power these devices with 24 volt AC power. Use the supplied power transformer, 16 VAC, 20 VA (or U.L. listed equivalent) to power the Access Plus unit. Do not power any other devices (electric strikes, magnetic locks, etc.) from this power transformer. For wire runs up to 100 feet, use 18 AWG wire. For wire runs up to 200 feet, use 16 AWG wire.

Surge Suppression and Grounding

Proper grounding and the use of surge suppressers can significantly reduce the chance of component failure because of static charges or surges. To be effective, ground connections should be made with a minimum 12 AWG wire to a ground point within 10 feet of the device being protected. The ground point must be at an electrical panel, a metallic cold water pipe that runs in the earth, or a grounding rod driven at least 10 feet into the soil. **A gooseneck mounting post anchored in concrete does not make a good ground.**

It is highly recommended that telephone line surge suppresser (DoorKing p/n 1877-010) be installed to help protect the system from phone line power surges and a low voltage surge suppresser (DoorKing p/n 1878-010) be installed to help protect the telephone entry system from power surges. Surge suppresser must be provided a ground point within three (3) feet of the surge device.

1.4 Telephone Auto-Dialer Wiring – Single Unit

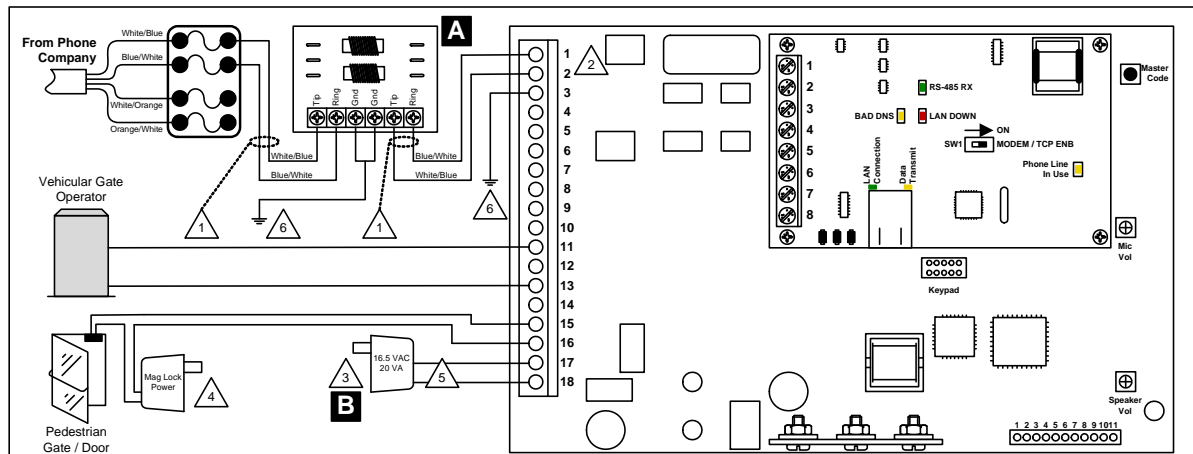

- 1 Use only twisted pair telephone wire that is rated for direct underground burial. **DO NOT use wire that is intended for indoor applications. Recommend Cat5e Gel Filled (flooded) UV Resistant Direct Burial Cable in conduit. DO NOT run telephone wires and high voltage wires in the same conduit.** Check the phone wire chart for wire size / distance.
- 2 Check for polarity on the phone "IN" wires, terminals 1 and 2. Terminal 2 must be positive with respect to terminal 1. Set a VOM meter to measure DC volts. Place the positive lead on terminal 2 and the negative lead on terminal 1. If the meter shows a positive voltage - OK. If the meter shows a negative voltage (needle moves off scale to the left), reverse the wires on terminals 1 and 2.
- 3 Use supplied 16.5 VAC, 20 VA power transformer or UL Listed equivalent. **DO NOT Power this device with a 24 Volt transformer or source voltage.**
- 4 Magnetic locks or electric strikes must be powered from a separate UL Listed power transformer. Do not power strikes or magnetic locks from the 1810 power transformer.
- 5 Use minimum 18 AWG wire for runs up to 100 feet; 16 AWG wire for runs up to 200 feet. It is recommended to keep power wire runs as short as possible. Check the power wire chart for wire size / distance.
- 6 Be sure to properly ground all devices. Minimum 12 AWG wire. Surge devices must have a ground point within 3-ft of the device.

A Optional DoorKing Surge Suppressor P/N 1877-010 (or equivalent) highly recommended.
 For best protection, surge suppressor ground wire must be 3-ft. or less in length. Use minimum 12 AWG wire.
 Ring is Positive with respect to Tip terminal. See

B This device is powered by a 16.5 VAC transformer. **DO NOT power this device with a 24 VAC transformer or power source.**

DOORKING, INC., INGLEWOOD, CA 90301		
Title: Access Plus System Auto-Dialer Wiring Basic wire connections – single unit.		
Date: 3/10	Dwg. No. M1810-AP-6-B	Rev. B

1.5 Telephone Auto-Dialer Wiring – Multiple Units

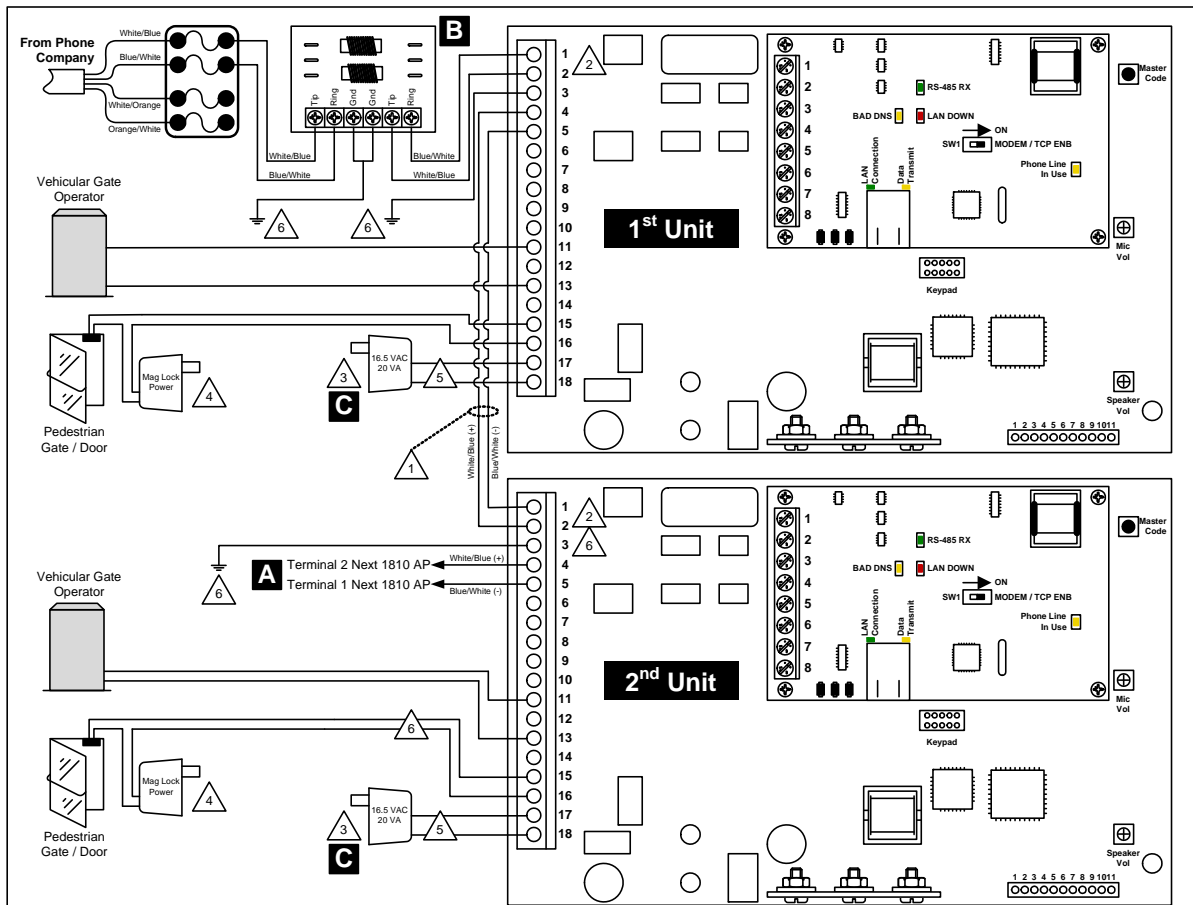

- 1** Use only twisted pair telephone wire that is rated for direct underground burial. **DO NOT use wire that is intended for indoor applications. Recommend Cat5e Gel Filled (flooded) UV Resistant Direct Burial Cable in conduit. DO NOT run telephone wires and high voltage wires in the same conduit.** Check the phone wire chart for wire size / distance.
- 2** Check for polarity on the phone "IN" wires, terminals 1 and 2. Terminal 2 must be positive with respect to terminal 1. Set a VOM meter to measure DC volts. Place the positive lead on terminal 2 and the negative lead on terminal 1. If the meter shows a positive voltage - OK. If the meter shows a negative voltage (needle moves off scale to the left), reverse the wires on terminals 1 and 2.
- 3** Use supplied 16.5 VAC, 20 VA power transformer or UL Listed equivalent. **DO NOT Power this device with a 24 Volt transformer or source voltage.**
- 4** Magnetic locks or electric strikes must be powered from a separate UL Listed power transformer. Do not power strikes or magnetic locks from the 1810 power transformer.
- 5** Use minimum 18 AWG wire for runs up to 100 feet; 16 AWG wire for runs up to 200 feet. It is recommended to keep power wire runs as short as possible. Check the power wire chart for wire size / distance.
- 6** Be sure to properly ground all devices. Minimum 12 AWG wire. Surge devices must have a ground point within 3-ft of the device.

A Maintain polarity when connecting multiple Access Plus units together! **A maximum of five (5) Access Plus units can be connected to the same phone line in this manner.**

When connecting multiple (more than 1) Access Plus units, the 1816 Access Plus telephone intercom feature cannot be used.

Terminal 5 connects to Terminal 1 of next Access Plus unit.
Terminal 4 connects to Terminal 2 of next Access Plus unit.

B Optional DoorKing Surge Suppressor P/N 1877-010 (or equivalent) highly recommended.

For best protection, surge suppressor ground wire must be 3-ft. or less in length. Use minimum 12 AWG wire.

Ring is Positive with respect to Tip terminal. See

C **This device is powered by a 16.5 VAC transformer. DO NOT power this device with a 24 VAC transformer or power source.**

DOORKING, INC., INGLEWOOD, CA 90301			
Title: Access Plus System Auto-Dialer Wiring Basic wire connections – multiple units.			
Date: 3/10	Dwg. No. M1810-AP-3-B	Rev. B	

1.6 Telephone Intercom Wiring

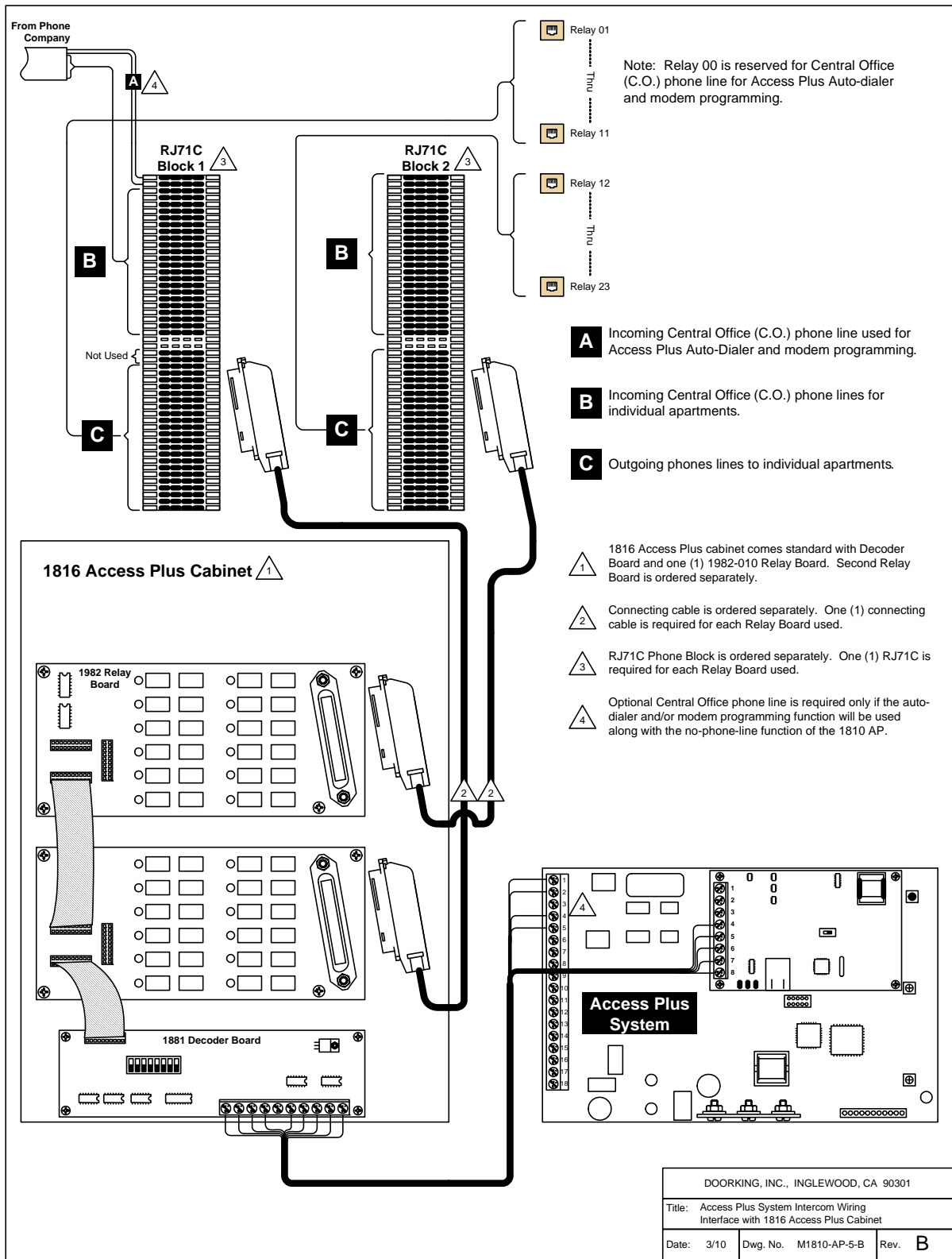

1.7 1816 Access Plus Detail Wiring

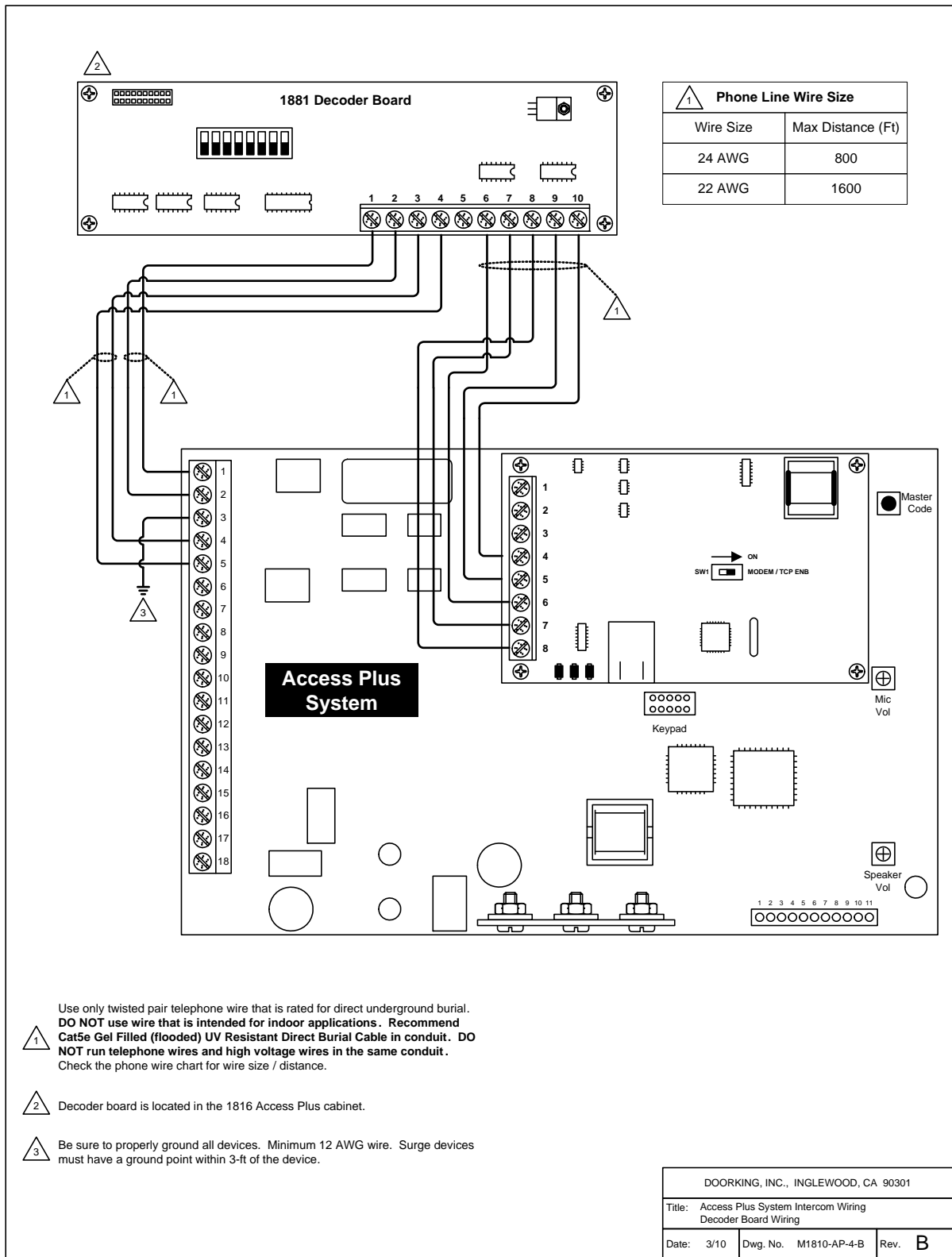

1.8 Main Terminal Description

Terminal	Description
1	Phone In (Negative)
2	Phone In (Positive)
3	Ground
4	Phone Out (Positive)
5	Phone Out (Negative)
6	Not Used.
7	Switch Input Relay 1. A switch closure across terminals 7 & 9 will activate relay 1 for its programmed strike time.
8	Switch Input Relay 2. A switch closure across terminals 8 & 9 will activate relay 2 for its programmed strike time.
9	- 12 VDC Battery Negative. Also common for terminals 7 & 8.
10	+ 12 VDC Battery Positive.
11	Relay 1 Normally Open
12	Relay 1 Normally Closed
13	Relay 1 Common
14	Relay 2 Normally Open
15	Relay 2 Normally Closed
16	Relay 2 Common
17	16.5 VAC Input Power
18	16.5 VAC Input Power

1.9 Access Plus Interface Board

The Access Plus interface board is piggybacked onto the main Access Plus circuit board. The interface board provides additional connections to the Access Plus unit for card readers, keypads and/or RF receivers using RS-485 communication protocol. It also provides connections to the 1816 Access Plus decoder board when the system is used in the telephone intercom mode.

Access Plus units can be programmed via a PC using a network or modem connection. An RJ-45 connector is provided on the interface board for network connections.

1.9.1 RS-485 Connection

Use the RS-485 terminals to add up to six (6) card readers, keypads and/or RF receivers to the Access Plus unit. These devices must be wired in a daisy-chain format with a maximum wire run distance of 4000 feet. We recommend that you use Cat5e wire for all RS-485 wire runs.

DO NOT power RS-485 devices from the Access Plus unit. These devices must be supplied with their own power source. Refer to the individual device wiring instructions for connection information and wiring guidelines for these products.

Be sure to set programming commands 09 (section 2.6.2) and 07 (section 2.6.3) when connecting RS-485 devices to the Access Plus unit.

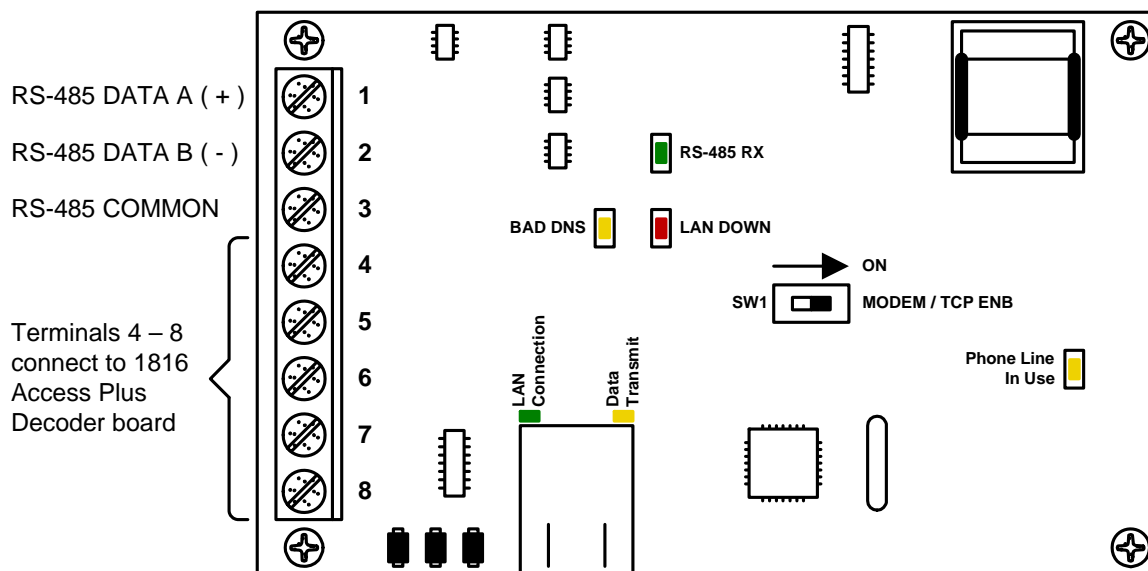

RS-485 Connections

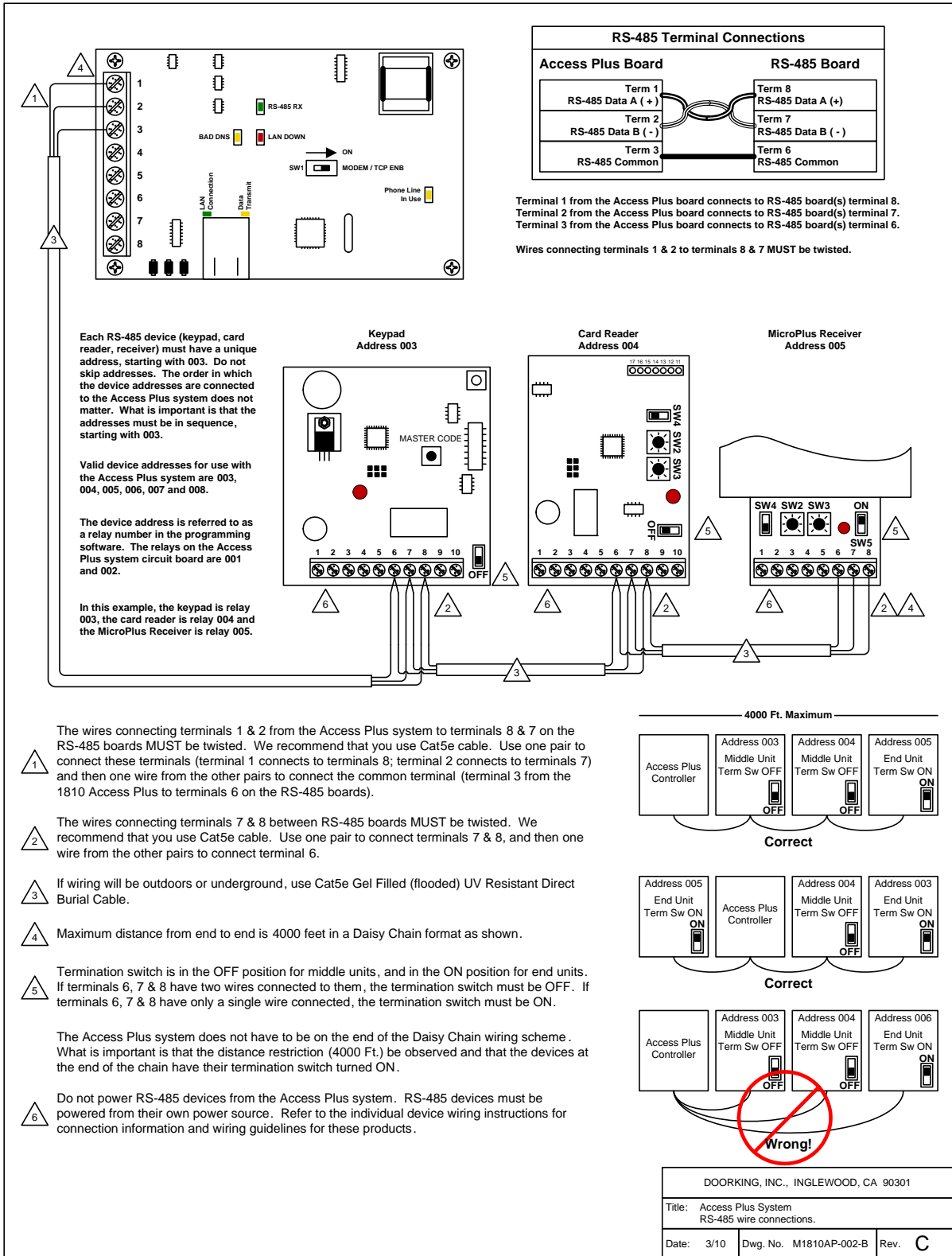

1.9.2 Network Connections

There are a number of ways to communicate with the Access Plus unit via a network connection. Before any programming can be attempted, you need to install the Access Plus Account Manager programming software on the computer you want to use for this purpose. The computer must have a network card installed. Follow the instructions in the software help guide and refer to section 2.3 for setup information.

Using a network connection, you can connect to the Access Plus unit in one of four different ways.

NOTE: Maximum distance on Cat5 wire runs is limited to 325 feet (100 meters).

- Locally with a direct connection from the computer to the Access Plus unit using a commercially available crossover cable.
- Locally by connecting the computer to the Access Plus unit through a router. This is a Local Area Network (LAN) connection.
- Through the internet with a static IP address. This is a Wide Area Network (WAN) connection and will require a router and a DSL or cable modem with an internet connection.
- Through the internet with a dynamic IP address. This is a Wide Area Network (WAN) connection and will require a router and a DSL or cable modem with an internet connection. You will also need a registered DDNS host name.

Direct Connection Using a Crossover Cable

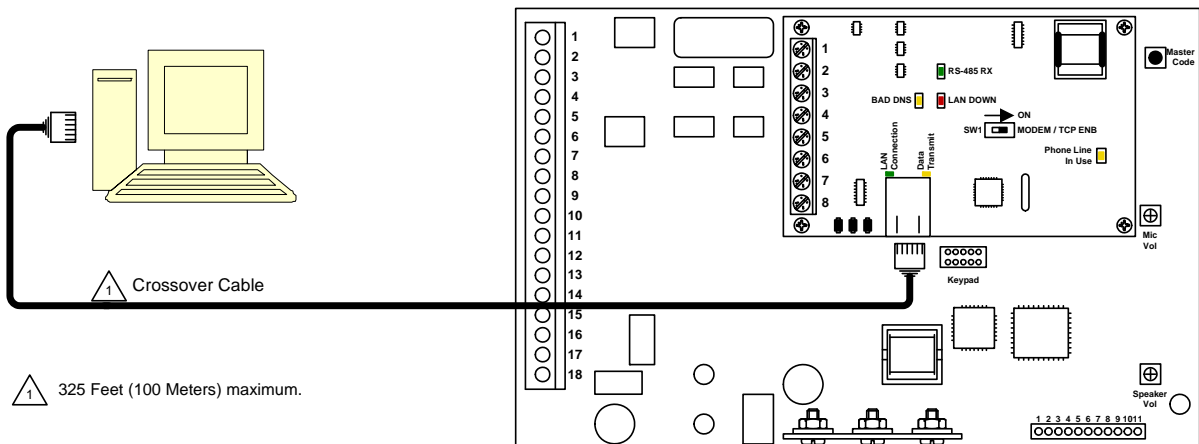

Direct Connection Using a Router (LAN)

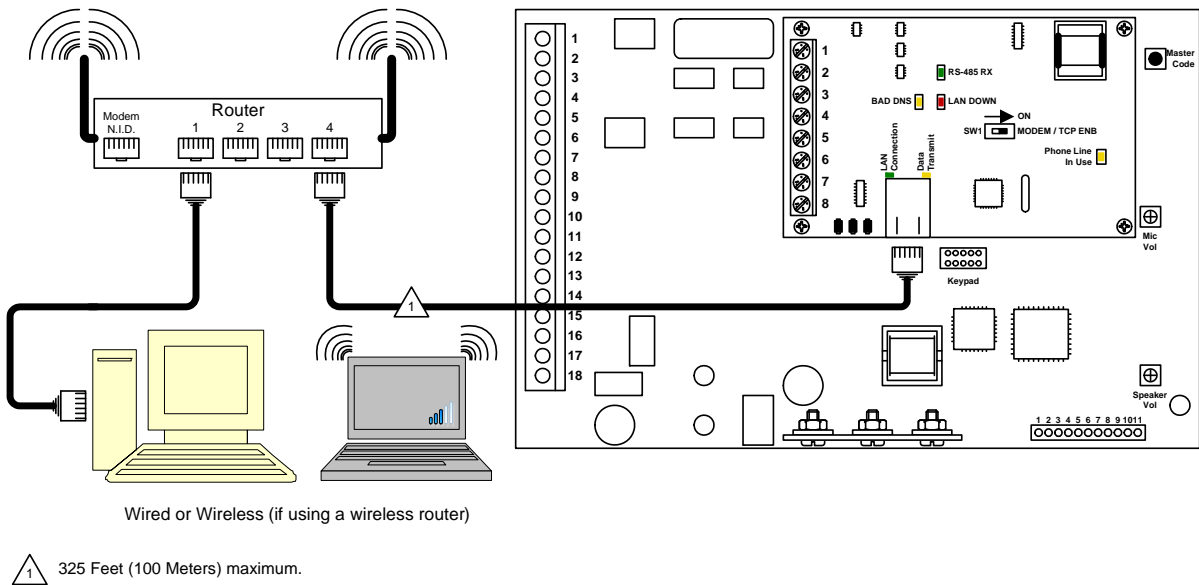

Through the Internet (WAN)

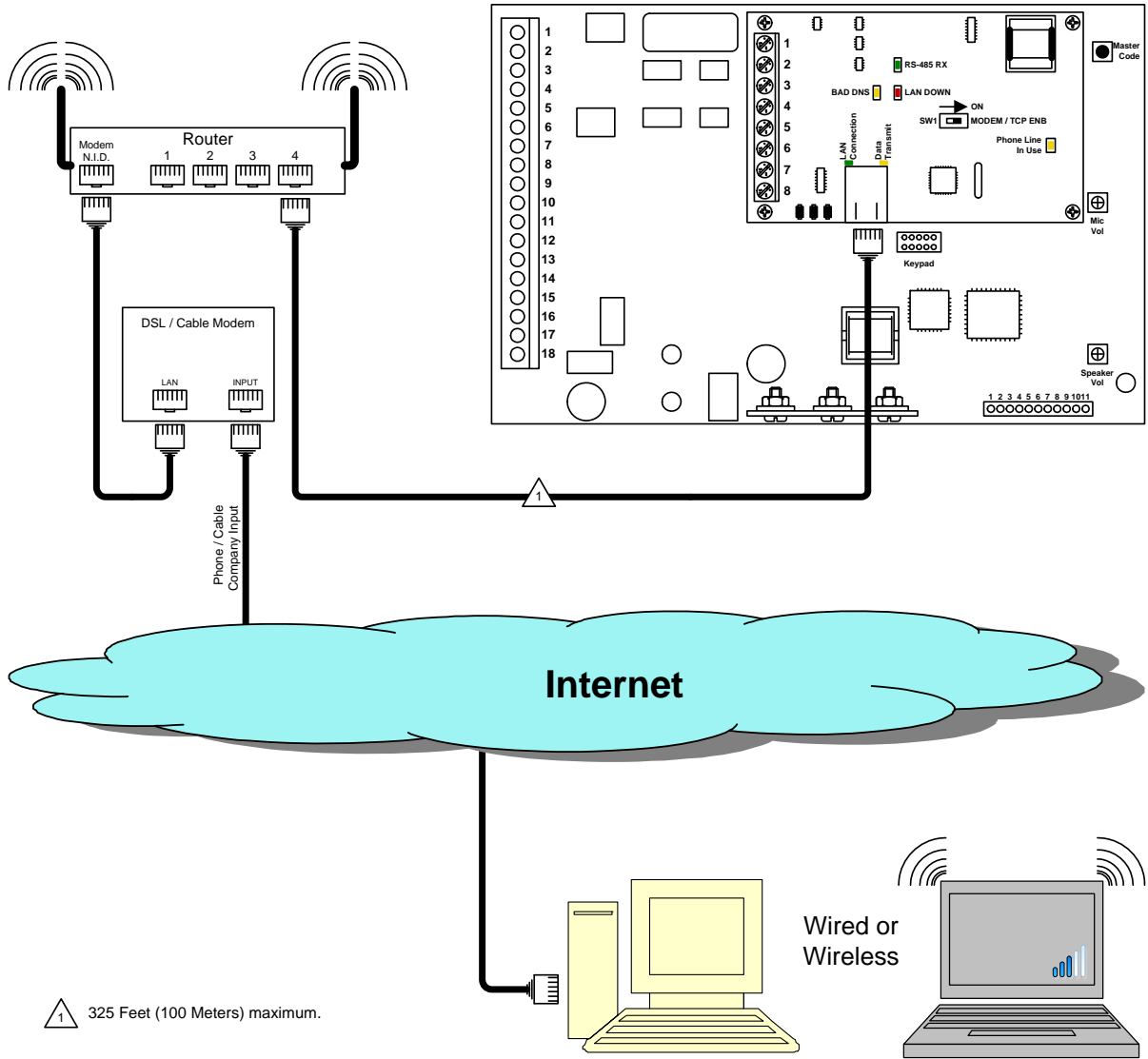

1.9.3 Modem Connections

Access Plus unit's have a built-in modem that can be used to connect to a PC. Before programming can be attempted, you need to install the Access Plus Account Manager programming software on the computer you want to use for this purpose. The computer must have a modem installed or an external modem connected to it. Follow the instructions in the software help guide for setup information.

Modem Connection – Auto-Dialer Configuration Only

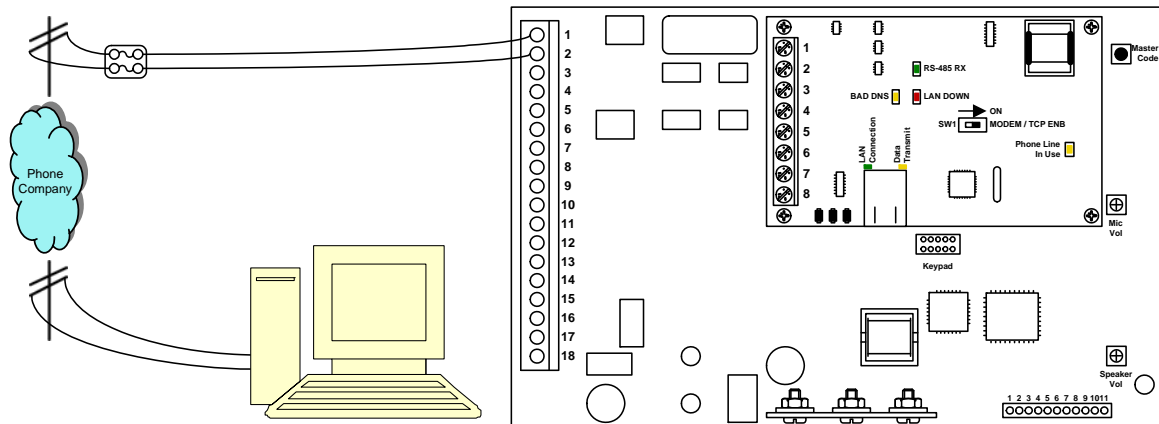

SECTION 2 – PROGRAMMING

Before You Start

IMPORTANT! We strongly suggest that you become familiar with these programming instructions before beginning any programming of the Access Plus unit.

The Access Plus unit has been programmed at the factory with many of the programming parameters already set (default setting) for a typical application with a single Access Plus unit. There is no need to reprogram these parameters unless you want to change them. For easy reference, refer to the chart on page 37 that list the various programming functions and their default settings.

2.1 Programming the Master Code

This programming step sets the system MASTER CODE. The master code is the four-digit number required to gain access to the unit's memory. **The master code can only be programmed from the unit's keypad.**

Default setting is NONE. You MUST program a Master Code.

1. Open the cabinet of the Access Plus unit and press the master code button. The Blinking LED next to the button will turn ON.
Note: After you press the master code push button, the LED will turn ON indicating that you are in the master code programming sequence. If a master code is not entered within 10 seconds, the master code program sequence will automatically end and the LED will return to a blinking state indicating that you have exited the master code programming sequence.
2. Enter a four-digit master code then press *. [_ _ _ _ * (**beep**)] (The LED will revert to Blinking).
3. Close the cabinet.

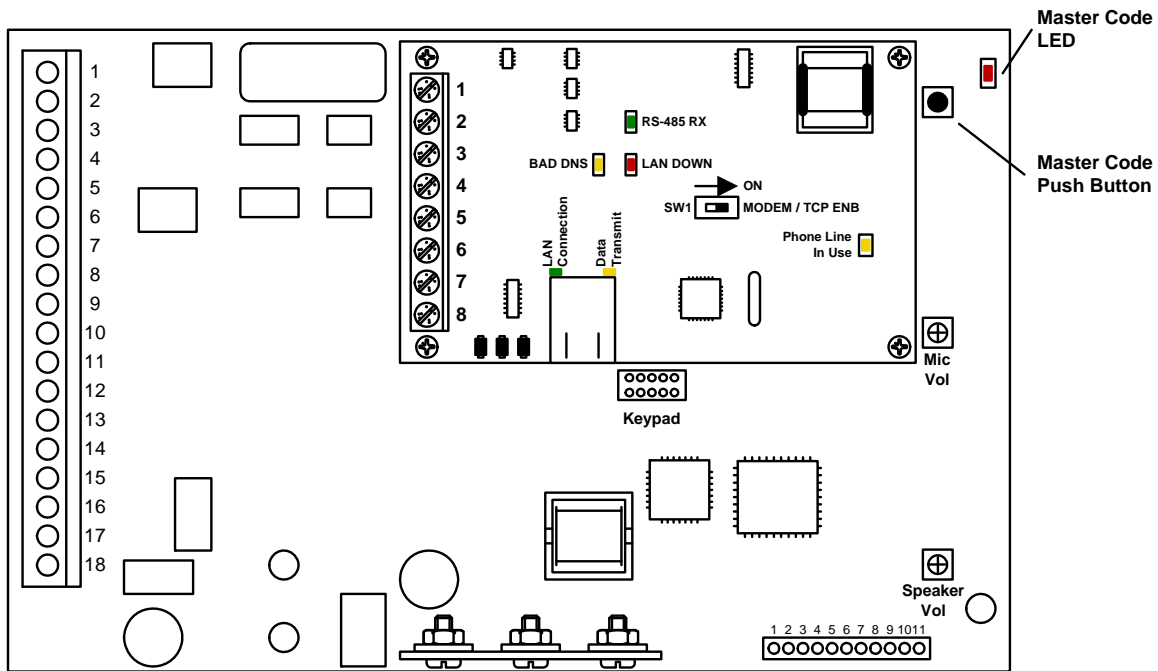

2.2 Programming Methods

Access Plus units can be programmed from a computer, the unit's keypad or from a touch-tone telephone connected to the unit. We highly recommend programming the Access Plus unit from a computer using the Access Plus Account Manager software as this greatly simplifies the programming task. There are also several features in the Access Plus unit that must be setup using a computer.

The following features and programming parameters can only be programmed from a computer.

Strike Out: This feature can be turned ON or OFF and will set the number of invalid access codes allowed before the system shuts down for a period of time. The default is OFF.

Holiday Schedules: Program up to 31 different Holiday schedules. This feature can be turned ON or OFF. The default is OFF.

Email Notification: Set the Access Plus unit to send emails to a specified email address on events of your choice - requires an Internet connection. This feature can be turned ON or OFF. The default is OFF.

Transaction Log: Download and view the system transaction log.

- **Computer (PC's only)**

This is the preferred method of programming the Access Plus unit as it will simplify all of the programming steps and allow you to enjoy all of the features and benefits available with this system. The Access Plus Account Manager software must be installed on your computer and the Access Plus unit must be connected to the computer via one of the methods shown in section 1.9.2 or 1.9.3. Refer to the software help screens for more information.

- **Keypad**

We strongly recommend that you become familiar with the entire programming sequence before attempting to program some of the more complex features of the Access Plus unit using the unit's keypad. If you make a single error in the programming steps, you will have to re-do the sequence from the beginning.

- **Touch-Tone Telephone**

The programmable features that can be programmed using the unit's keypad can also be programmed using a touch-tone telephone from any outside phone line by calling into the Access Plus unit. This method of programming is useful for programming simple steps or for turning certain features ON or OFF, but is not recommended for complex programming steps.

2.3 Programming with a Computer (Network Setup)

Before proceeding with any of the programming steps in this section, install the Access Plus Account Manager software on the computer that will be used for this purpose. Be sure that the computer has a network card installed, or a modem installed in it (or connected to it) depending on which connection method will be used. Once the software is installed and the Access Plus unit is connected, refer to the software programming steps and help screen instructions to proceed with the programming steps in this section.

Be sure that SW1 is in the ON position (MODEM/TCP ENB) on the interface board.

Reboot: If a programming step calls for a reboot, follow the programming steps in 2.3.1. If you are performing several programming steps that call for a reboot, complete all of those steps first, then perform the reboot sequence in 2.3.1.

2.3.1 Enable / Disable TCP / IP Support – System Reboot

Default value is: 0 (Disabled)

This programming sequence enables or disables the support for TCP / IP. It will also cause an automatic reboot of the Access Plus unit two seconds after the programming sequence is completed. For this reason, **perform this step after all other network setup programming sequences have been completed (2.3.2 through 2.3.5) or whenever an individual network programming step is performed.**

1. Press * 5 0 and enter the MASTER CODE. [*** 5 0 _ _ _ _ (beep)**]
2. Press 0 * to disable OR press 1 * to enable. [**_ * (beep)**]
3. The system will reboot automatically.

Once the Access Plus unit is connected, the green LED on the RJ-45 jack on the interface board should light indicating that a good wire connection has been made. The LAN DOWN LED should go off after a few seconds if all previous programming steps have been completed and programmed successfully.

2.3.2 Set the Access Plus Unit IP Address (reboot required)

Default value is: 192.168.001.030

This must be set to the same address that was programmed in the software. A valid value for any of the three digit numbers in this sequence is 000 to 255.

1. Press * 5 1 and enter the MASTER CODE. [*** 5 1 _ _ _ _ (beep)**]
2. Enter the IP address. Use the * key to enter the “dot.”
[**_ _ _ * (beep) _ _ _ * (beep) _ _ _ * (beep) _ _ _ * (beep)**]
3. Press 0 # TOGETHER to end. [**0 # (beeeeeep)**]

2.3.3 Sub-Net Mask (reboot required)

Default value is: 255.255.255.000

All sub-net mask should be set to 255.255.255.000. If not, consult your network expert. Valid values for any of the three digit numbers is 000 to 255.

1. Press * 5 2 and enter the MASTER CODE. [*** 5 2** _ _ _ _ (beep)]
2. Enter the sub-net mask number. Use the * key to enter the "dot."
[_ _ _ * (beep) _ _ _ * (beep) _ _ _ * (beep) _ _ _ * (beep)]
3. Press 0 # TOGETHER to end. [**0 # (beeeeeep)**]

2.3.4 Set the Gateway (router) IP Address (reboot required)

Default value is: 192.168.001.001

If the Access Plus unit is connected directly to the computer with a crossover cable, then this address must be set to 000.000.000.000. If the Access Plus unit is connected to the computer through a router, then set this value to the router's IP address. Valid value for any of the three digit numbers is 000 to 255.

1. Press * 5 3 and enter the MASTER CODE. [*** 5 3** _ _ _ _ (beep)]
2. Enter the gateway (router) IP address. Use the * key to enter the "dot."
[_ _ _ * (beep) _ _ _ * (beep) _ _ _ * (beep) _ _ _ * (beep)]
3. Press 0 # TOGETHER to end. [**0 # (beeeeeep)**]

2.3.5 Set the Port Number (reboot required)

Default value is: 01030

This must be the same port number that was programmed in the software. Valid values are 01024 to 65535.

1. Press * 5 6 and enter the MASTER CODE. [*** 5 6** _ _ _ _ (beep)]
2. Enter the port number, then press *. [_ _ _ _ _ * (beep)]
3. Press 0 # TOGETHER to end. [**0 # (beeeeeep)**]

STOP!

If you are using a computer with the Access Plus unit, no other programming at the keypad is required. All programming parameters beyond this point can be set in the Access Plus Account Manager software.

2.4 System Parameters Programming

IMPORTANT! We strongly suggest that you read these programming instructions in their entirety before beginning any manual programming of the Access Plus unit.

The programming table on the next page provides a quick reference to the

Programming from the Keypad

Follow the programming instructions as described in each section of this manual. The unit will prompt you with short tones (beep) when programming steps have been followed correctly and with a long tone (beeeeeep) when the programming step is ended.

Programming with a Touch-Tone Telephone

Follow these steps when programming the Access Plus unit from an off-site touch-tone telephone. NOTE: The Access Plus unit must be programmed to answer incoming calls, section 2.4.7.

1. Call the telephone number of the Access Plus unit. The Access Plus unit will answer with a short beep after the programmed number of rings.
2. Follow the programming instructions as described in each section of this manual. The unit will prompt you with short (beep) tones when programming steps have been followed correctly.
3. When complete, hang up.

System Parameters Programming Section 2.4			
Description	Command	Section	Default Value
Single / Multiple Units	* 6 1	2.4.1	Single
Single or Double Ring (1816 Access Plus only)	* 6 3	2.4.2	Double
Number of Rings to Resident (1816 Access Plus only)	* 6 4	2.4.3	5
Talk Time	* 0 8	2.4.4	60 Sec.
Relay Strike Time	* 0 3	2.4.5	1 Sec
Tone Open Numbers	* 0 5	2.4.6	Relay 1: 9 8 7 6 Relay 2: 5 4 3 2
Answer Incoming Call on X Rings	* 1 8	2.4.7	6
Hang-up Tone	* 1 7	2.4.8	0
Call Waiting On / Off (1816 Access Plus only)	* 2 0	2.4.9	ON
Turn Speaker On From Outside Call	* 1 6	2.4.10	N / A
Set Microphone Gain & Speaker Volume	* 1 1	2.4.11	7 1

Directory Codes Section 2.5			
Description	Command	Section	Default Value
Directory Codes 24 – 50 Dial Phone Number	* 4 1	2.5.1	Empty
Delete Single Phone Number from Directory Codes 24 – 50	* 4 2	2.5.2	N / A
Delete All Phone Numbers from Directory Codes 24 - 50	* 4 3	2.5.3	N / A

Devices Section 2.6			
Description	Command	Section	Default Value
Program Simple Access Code	* 0 2	2.6.1	Empty
Program Number of RS-485 Devices	* 0 9	2.6.2	
Program RS-485 Device Off-Line Function	* 0 7	2.6.3	
Program Access Code	* 7 0	2.6.4	Empty
Delete Access Code	* 7 1	2.6.5	N / A
Delete All Access Codes	* 7 2	2.6.6	N / A
Program Temporary Access Codes	* 7 3	2.6.7	Empty
Delete Temporary Access Code	* 7 4	2.6.8	N / A
Delete All 10 Temporary Access Codes	* 7 5	2.6.9	N / A

Time Functions Section 2.7			
Description	Command	Section	Default Value
Program Calendar Chip	* 3 3	2.7.1	Empty
Program Relay Hold Schedule	* 3 5	2.7.2	Empty
Program Time Zones	* 3 6	2.7.3	Empty

Miscellaneous Section 2.8			
Description	Command	Section	Default Value
Restore Defaults	* 9 0	2.8.1	N / A
Erase Transaction Log	* 9 1	2.8.2	N / A

2.4.1 Single or Multiple Units

Default setting is 1 (Single Unit).

Set for single if only one Access Plus unit is connected to the phone line, or set to multiple if more than one Access Plus units are connected to the phone line.

1. Press * 6 1 and then enter the MASTER CODE. [*** 6 1** _ _ _ _ (beep)]
2. Press 1 * for a single system **OR** press 0 * for multiple systems. [**_ *** (beep)]
3. Press 0# TOGETHER to end. [**0# (beeeeeep)**]

2.4.2 Single or Double Ring

Default setting is 1 (Double Ring).

The Access Plus unit can be used in both an auto-dialer and/or telephone intercom configuration. When used as an auto-dialer, the double ring programming has no affect on the ring – this is controlled by the phone company and it will always be the standard single ring no matter how the ring is programmed in the Access Plus unit.

In the telephone intercom mode connected to the 1816 AP module, the double ring provides a unique ring so that a call from the Access Plus unit is easily identified by the resident.

1. Press * 6 3 and then enter the MASTER CODE. [*** 6 3** _ _ _ _ (beep)]
2. Press 1 * for a double ring **OR** press 0 * for a single ring. [**_ *** (beep)]
3. Press 0# TOGETHER to end. [**0# (beeeeeep)**]

2.4.3 Number of Rings to Ring Residence

Default setting is 05 (5 Rings).

This programming step is only used if the Access Plus unit is connected with the 1816 Access Plus interface. This programming step is not applicable when the Access Plus unit is used as an auto-dialer. This programming sequence sets the number of unanswered rings to the apartment before the Access Plus unit hangs up.

1. Press * 6 4 and then enter the MASTER CODE. [*** 6 4 _ _ _ _ (beep)**]
2. Enter the number of rings before unit hangs up (01-99) then press *. [**_ _ * (beep)**]
3. Press 0# TOGETHER to end. [**0# (beeeeeep)**]

2.4.4 Talk Time

Default setting is 060 (60 Seconds).

This programming sequence sets the maximum time allowed for conversation when the Access Plus unit places a call either through the 1816 telephone intercom interface (directory codes 01-23) or through the auto-dialer (directory codes 24-50). Talk time can be set from 10 seconds up to 255 seconds (4 minutes, 15 seconds) and is entered as a three-digit number. For example, to set a talk time of 30 seconds, enter 030 in step 2.

1. Press * 0 8 and enter the MASTER CODE. [*** 0 8 _ _ _ _ (beep)**]
2. Enter the talk time code (010-255) then press *. [**_ _ _ * (beep)**]
3. Press 0# TOGETHER to end. [**0# (beeeeeep)**]

2.4.5 Relay Strike Time

Default setting for Relays 1 and 2 is 01 (1 Second). Relays 3 through 8 are not set.

These steps will program the system relay strike times. Strike times can be programmed from 1/4 second (enter 00 in step 3) up to 99 seconds.

System relays 1 and 2 are the two relays on the Access Plus unit main circuit board. System relays 3 through 8 are the relays associated with additional RS-485 devices (card readers, keypads, RF receivers, etc.) connected to the system.

1. Press * 0 3 and enter the MASTER CODE. [*** 0 3 _ _ _ _ (beep)**]
2. Enter a relay number (1 – 8), then press *. [**_ * (beep)**]
3. Enter the two-digit strike time (00-99) then press *. [**_ _ * (beep)**]
4. Repeat steps 2 and 3 to set other relay strike times.
5. Press 0# TOGETHER to end. [**0# (beeeeeep)**]

2.4.6 Tone Open Numbers

Default setting is 9876 for relay 1; 5432 for relay 2. Relays 3 – 8 are not set.

These steps will program the tone open number(s) for each relay in the system (each relay is programmed independently). You will need to enter a four-digit number (see chart below) to set each relay. If a function is not desired, enter # in place of a number. For example, if you want the relay to have a momentary activation function only, and you want the relay to activate when the number 9 is pressed, enter 9 # # # in step 3.

1. Press * 0 5 and enter the MASTER CODE. [*** 0 5 _ _ _ _ (beep)**]
2. Enter a relay number (1 – 8), then press *. [**_ * (beep)**]
3. Enter the four-digit tone open number code then press *. [**_ _ _ _ * (beep)**]
4. Repeat steps 2 and 3 to set other relay tone open numbers.
5. Press 0# TOGETHER to end. [**0# (beeeeeep)**]

4 Digit Tone Open Number Code	Function
1 st Digit	Momentary activation. The relay will activate for its programmed strike time.
2 nd Digit	Hold open. The relay will activate and remain activated until commanded to deactivate.
3 rd Digit	Deactivate relay.
4 th Digit	Hold open 1 hour. The relay will activate for 1 hour and then deactivate itself.

2.4.7 Answer Incoming Call on X Rings

Default setting is 06 (6 Rings).

This programming section sets the number of rings that the Access Plus unit will allow before it picks up the call. The number of rings to answer can be set from 1 to 12 rings and must be entered as a two-digit number. For example, if you want the unit to answer the call after the sixth ring, enter 0 6 in step 2. If you program 00 in step 2, this will prevent (disable) the unit from answering incoming calls to it.

1. Press * 1 8 and enter the MASTER CODE. [*** 1 8 _ _ _ _ (beep)**]
2. Enter the number of rings (01 – 99) then press *. [**_ _ * (beep)**]
(enter 00 in this step to disable this feature)
3. Press 0# TOGETHER to end. [**0# (beeeeeep)**]

2.4.8 Hang Up Tone

Default setting is 0.

These steps set the number that will hang-up the Access Plus unit after conversation is completed.

1. Press * 1 7 and enter the MASTER CODE. [* 1 7 _ _ _ _ (beep)]
2. Enter the hang up tone number then press *. [_ * (beep)]
3. Press 0# TOGETHER to end. [0# (beeeeeep)]

2.4.9 Call Waiting

Default setting is 1 (Call Waiting On).

This programming step is only used if the Access Plus unit is connected with the 1816 Access Plus interface. This programming step is not applicable when the Access Plus unit is used as an auto-dialer. These steps will turn the Call Waiting feature either ON or OFF. The call waiting feature will allow the resident to place an outside call on hold when a visitor places a call from the Access Plus unit to the resident through directory codes 01-23. Once communication with the visitor is established, access can be granted or denied. If access is granted (press the number to open the door or gate), the unit will automatically switch the call back to the outside call. If the resident wants to deny access, they simply press the # key to switch back to the outside call.

1. Press * 2 0 and enter the MASTER CODE. [* 2 0 _ _ _ _ (beep)]
2. Press 1 * to turn Call Waiting ON, **OR** 0 * to turn Call Waiting OFF. [_ * (beep)]
3. Press 0# TOGETHER to end. [0# (beeeeeep)]

2.4.10 Turn Speaker On

This command allows you to call the Access Plus unit from a remote location and turn on the speaker at the unit to enable two-way voice communication and will allow relay control – all tone open numbers that are programmed (2.4.8).

1. Call the phone number the Access Plus unit is installed on. After the programmed number of rings (2.4.9) the unit will answer with a tone.
2. Press * 1 6 and enter the MASTER CODE. [* 1 6 _ _ _ _ (beep)]
3. Hang up when your conversation is completed.

2.4.11 Set Microphone Gain and Speaker Volume

Default setting is 71.

This adjustment is required only if the Access Plus unit is being used in the auto-dialer mode (directory codes 24-50). This step will adjust the microphone gain (the remote handset loudness) and the speaker volume (the Access Plus unit loudness) during call forwarding operation. You may have to perform these steps several times to get the optimal microphone gain and speaker volume adjustment.

Before making any adjustments, do a test call as the programmed defaults may work fine for you and no additional adjustments may be necessary. If adjustments are made, you will need to do a call forward test call after each adjustment to determine if the result is to your liking.

The valid values for both the microphone gain and speaker volume are 0 through 9. These values are entered as a two-digit number in step 2 below. The first digit is the microphone gain; the second digit is the speaker volume. The default setting is 71, which means that the microphone gain is set to 7 and the speaker volume is set to 1. A higher value increases the loudness where as a lower value decreases the loudness.

1. Press * 1 1 and enter the MASTER CODE. [*** 1 1 _ _ _ _ (beep)**]
2. Enter a two-digit microphone gain and speaker loudness setting, then press *.
[**_ _ * (beep)**]
3. Press 0# TOGETHER to end. [**0# (beeeeeep)**]

2.5 Directory Codes

NOTE: Directory codes 01-23 are pre-set to dial relay numbers and telephone intercom lines associated with the 1816 system. Directory codes 24-50 are used for auto-dialer numbers.

2.5.1 Directory Codes 24 – 50 Dial Phone Number

The Access Plus system has the capability of operating as an auto-dialer and can store up to 27 phone numbers in its memory. When a visitor enters a directory code on the system keypad, the Access Plus unit will call the phone number programmed under the specific directory code number. Valid directory codes that can be used for the auto-dialer function are 24 through 50 only.

1. Press * 4 1 and enter the MASTER CODE. [* 4 1 _ _ _ _ (beep)]
2. Enter a two-digit directory code (24-50) then press *. [_ _ * (beep)]
3. Enter the phone number (up to 20 digits) then press *. [_ _ _ _ _ _ _ _ _ _ _ _ _ _ _ _ * (beep)]
4. Repeat steps 2 and 3 to enter additional numbers.
5. Press 0# TOGETHER to end. [0# (beeeeeep)]

2.5.2 Delete Phone Number from Directory Codes 24 - 50

This programming sequence deletes individual directory code dial-out phone numbers from the system memory.

1. Press * 4 2 and enter the MASTER CODE. [* 4 2 _ _ _ _ (beep)]
2. Enter a two-digit directory code (24-50) of the phone number you want to delete then press *. [_ _ * (beep)]
3. Repeat step 2 to delete additional numbers.
4. Press 0# TOGETHER to end. [0# (beeeeeep)]

2.5.3 Delete All Phone Numbers from Directory Codes 24 - 50

This programming sequence will delete all directory code dial-out phone numbers stored in the system memory.

WARNING: once started, all phone numbers will be erased.

1. Press * 4 3 and enter the MASTER CODE. [* 4 3 _ _ _ _ (Beep)]
2. Press 9 9 9 9 then press *. [9 9 9 9 * (beep)]
3. The programming sequence will end itself automatically. [beeeeeep]

2.6 Access Devices

NOTE: All access codes are five (5) digits in length.

2.6.1 Simple Access Code Programming

This programming sequence programs simple access codes used on the Access Plus units keypad into the system memory. Simple access codes cannot be time zone restricted; they can only be assigned to operate either relay 1 or relay 2 on a 24/7 basis. If you require access codes to be time zone restricted, use the programming sequence in 2.6.4.

Note: Up to 50 access codes can be programmed into the system via the Access Plus unit keypad. This 50 includes access codes programmed in 2.6.1 AND 2.6.4. For example, if 10 access codes are programmed in 2.6.1, then only 40 can be programmed in 2.6.4

1. Press * 0 2 and enter the MASTER CODE. [*** 0 2 _ _ _ _ (beep)**]
2. Press 1 for relay 1 **OR** Press 2 for relay 2, then press *. [**_ * (beep)**]
3. Enter a five-digit access code then press *. [**_ _ _ _ _ * (beep)**]
4. Repeat steps 2 and 3 to enter additional codes.
5. Press 0# TOGETHER to end. [**0# (beeeeeep)**]

2.6.2 Number of RS-485 Devices

Default value is 0.

This programming sequence sets how many remote RS-485 devices are connected to the Access Plus unit.

1. Press * 0 9 and enter the MASTER CODE. [*** 0 9 _ _ _ _ (beep)**]
2. Enter the number of RS-485 devices connected, then press *. Valid numbers are 0 through 6. Entering a 0 in this step will disable RS-485 communication.
[**_ * (beep)**]
3. Press 0 # TOGETHER to end. [**0 # (beeeeeep)**]

2.6.3 Additional Relay Off-Line Function

Default value is 0.

This programming sequence sets how the remote RS-485 devices connected to the Access Plus unit will behave if RS-485 communication to the device fails.

Entering a 1 in step 2 sets the remote device to grant access to any five-digit card, transmitter or access code, whether it has been programmed into the system or not, if RS-485 communication fails. Entering a 0 in step 2 means that access will not be granted at the device if RS-485 communication fails. In this case, the Access Plus unit and any other remote devices may still be operating normally as long as they have a good RS 485 communication link.

1. Press * 0 7 and enter the MASTER CODE. [*** 0 7 _ _ _ _ (beep)**]
2. Enter a 0 or 1, then press *. [**_ * (beep)**]
3. Press 0 # TOGETHER to end. [**0 # (beeeeeep)**]

2.6.4 Device Access Code Programming

This programming sequence programs device (card readers, keypads, RF receivers, etc.) access codes into the system memory with time zone restrictions applied. It also allows programming of the device access codes to momentarily activate a relay or to hold (latch) a relay.

1. Press * 7 0 and enter the MASTER CODE. [*** 7 0 _ _ _ _ (beep)**]
2. Enter the device type (0=card, 1=transmitter, 2=keypad, 3=other), then press *. [**_ * (beep)**]
3. Enter the five-digit device access code then press *. [**_ _ _ _ _ * (beep)**]
4. Enter a minimum of 1, and a maximum of 4 time zones (valid time zones are 0 through 6) that you want to apply to this access code, then press *. [**_ _ _ _ * (beep)**]
Time zone 0 is always deny access, time zone 1 allows 24/7 access for relay 1 and any additional relays; time zone 2 allows 24/7 access for relay 2 and any additional relays. Time zones 3, 4, 5 and 6 are time zones that have been programmed in 2.7.3.
5. Enter 0 * for momentary relay activation or enter 1 * to hold (latch) the relay. [**_ * (beep)**]
6. Repeat steps 2 through 5 to program additional device access codes.
7. Press 0# TOGETHER to end. [**0# (beeeeeep)**]

2.6.5 Delete Device Access Codes

This programming sequence deletes device access codes that have been programmed into the system.

1. Press * 7 1 and enter the MASTER CODE. [*** 7 1 _ _ _ _ (beep)**]
2. Enter the device type (0=card, 1=transmitter, 2=keypad, 3=other), then press *. [**_ * (beep)**]
3. Enter the five-digit device access code to be deleted then press *. [**_ _ _ _ _ * (beep)**]
4. Repeat steps 2 and 3 to delete additional device access code numbers.
5. Press 0# TOGETHER to end. [**0# (beeeeeep)**]

2.6.6 Delete All Device Access Codes (of the same type)

This programming sequence deletes all device access codes for the same type of device.

WARNING: Once started, all devices of a type will be erased.

1. Press * 7 2 and enter the MASTER CODE. [*** 7 2 _ _ _ _ (beep)**]
2. Enter the device type (0=card, 1=transmitter, 2=keypad, 3=other), then press *. [**_ * (beep)**]
3. Press 9 9 9 9 then press *. [**9 9 9 9 * (beep)**]
4. The programming sequence will end itself automatically. [**beeeeeep**]

2.6.7 Temporary Device Access Code Programming

This programming sequence programs up to 10 temporary device access codes with a beginning and ending date and any time zone restrictions that may need to be applied.

1. Press * 7 3 and enter the MASTER CODE. [*** 7 3** _ _ _ _ (beep)]
2. Enter the device type (0=card, 1=transmitter, 2=keypad, 3=other), then press *. [**_ *** (beep)]
3. Enter a five-digit device access code then press *. [**_ _ _ _ _ *** (beep)]
4. Enter the beginning month (01-12) and day (01-31) then press *. [**_ _ _ _ *** (beep)]
5. Enter the ending month (01-12) and day (01-31) then press *. [**_ _ _ _ *** (beep)]
6. Enter a minimum of 1, and a maximum 4 time zones (valid time zones are 0 through 6) that you want to apply to this access code, then press *. [**_ _ _ _ *** (beep)]
Time zone 0 is always deny access, time zone 1 allows 24/7 access for relay 1 and any additional relays; time zone 2 allows 24/7 access for relay 2 and any additional relays. Time zones 3, 4, 5 and 6 are time zones that have been programmed in 2.7.3.
7. Press 0 * for momentary relay activation **OR** press 1 * to hold (latch) the relay.
[**_ *** (beep)]
8. Repeat steps 2 through 7 to program additional temporary device access codes.
9. Press 0# TOGETHER to end. [**0# (beeeeeep)**]

2.6.8 Delete Temporary Device Access Codes

This programming sequence deletes temporary device access codes that have been programmed into the system.

1. Press * 7 4 and enter the MASTER CODE. [*** 7 4** _ _ _ _ (beep)]
2. Enter the device type (0=card, 1=transmitter, 2=keypad, 3=other), then press *. [**_ *** (beep)]
3. Enter a five-digit device access code then press *. [**_ _ _ _ _ *** (beep)]
4. Repeat steps 2 and 3 to delete additional device access code numbers.
5. Press 0# TOGETHER to end. [**0# (beeeeeep)**]

2.6.9 Delete All Temporary Device Access Codes

This programming sequence deletes all (10) temporary device access codes that have been programmed into the system.

WARNING: Once started, all temporary access codes will be erased.

1. Press * 7 5 and enter the MASTER CODE. [*** 7 5** _ _ _ _ (beep)]
2. Press 9 9 9 9 then press *. [**9 9 9 9 *** (beep)]
3. The programming sequence will end itself automatically. [**beeeeeep**]

2.7 Time Functions

2.7.1 Program Calendar Chip

This programming sequence programs the calendar chip in the Access Plus unit for the current time and date. The calendar chip must be programmed if any of the time related features are going to be used.

Note: The clock / calendar chip in the Access Plus unit will keep time for approximately 48 hours if power to the system is lost or removed. If power is off longer than this, the clock / calendar chip will have to be reprogrammed.

1. Press * 3 3 and enter the MASTER CODE. [*** 3 3 _ _ _ _ (beep)**]
2. Enter the current hour (01-12) and minutes (01-59) then press *. [**_ _ _ _ * (beep)**]
3. Press 0 * for AM, **OR** press 1 * for PM. [**_ * (beep)**]
4. Enter the month (01-12) day of the month (01-31) and the year (00-99) then press *. [**_ _ _ _ _ * (beep)**]
5. Enter the day of the week (1-7) then press *. [**_ * (beep)**]
Sun = 1, Mon = 2, Tue = 3, Wed = 4, Thu = 5, Fri = 6, Sat = 7.
6. Press 0# TOGETHER to end. [**0# (beeeeeep)**]

EXAMPLE: Saturday, February 14th, 2009, 11:30 AM.

1. * 3 3 _ _ _ _ (beep)
2. 1 1 3 0 * (beep)
3. 0 * (beep)
4. 0 2 1 4 0 9 * (beep)
5. 7 * (beep)
6. 0 # (beeeeeep)

2.7.2 Relay Hold Schedule

Default setting in step 3 is 0 (Hold schedules are OFF).

This program sequence sets up schedules to automatically activate and deactivate relays 1 through 8. Four schedules can be programmed, each of which can be assigned to the desired relay(s). These schedules can be independently turned on or off after they have been programmed.

1. Press * 3 5 and enter the MASTER CODE. [*** 3 5 _ _ _ _ (beep)**]
2. Enter a schedule number (1, 2, 3 or 4) then press *. [**_ * (beep)**]
3. Press 0 * to turn the schedule off, **OR** press 1 * to turn the schedule on. [**_ * (beep)**]
You can terminate here (step 11) if you have previously programmed the schedules and only ON / OFF is desired.
4. Enter the begin time hour (01-12) and minutes (01-59) then press *. [**_ _ _ _ * (beep)**]
5. Press 0 * for AM, **OR** press 1 * for PM. [**_ * (beep)**]
6. Enter the end time hour (01-12) and minutes (01-59) then press *. [**_ _ _ _ * (beep)**]
7. Press 0 * for AM, **OR** press 1 * for PM. [**_ * (beep)**]
8. Enter the days of the week that the hold open schedule is to be active then press *. [**_ _ _ _ _ _ * (beep)**]
Sun = 1, Mon = 2, Tue = 3, Wed = 4, Thu = 5, Fri = 6, Sat = 7.
You can enter up to 7 numbers here (1-7). For example, for the hold open schedule to be active only on Saturdays and Sundays, enter 1 7. The order of the numbers is not important; 17 is the same as 71.
9. Enter the relay number(s) that the schedule will apply to, then press *. [**_ * (beep)**]
You can enter a single relay number here; all relay numbers, or any combination of relay numbers.
10. Repeat steps 2 through 9 to program the other time zones.
11. Press 0# TOGETHER to end. [**0# (beeeeeep)**]

2.7.3 Time Zones

Default setting in step 3 is 0 (Time Zones are OFF).

This programming sequence sets up time zones (up to 4) that can be applied to the device access codes programmed into the Access Plus unit. These time zones can be turned on or off once they have been programmed.

1. Press * 3 6 and enter the MASTER CODE. [*** 3 6 _ _ _ _ (beep)**]
2. Enter a time zone number (3, 4, 5 or 6) then press *. [**_ * (beep)**]
Do not use 0, 1 or 2 for time zone numbers. These are already used; 0 = always deny, 1 = 24/7 access for relay 1, and relays 3-8; 2 = 24/7 access for relay 2, and relays 3-8.
3. Press 0 * to turn time zone off, **OR** press 1 * to turn time zone on. [**_ * (beep)**]
You can terminate here (step 11) if you have previously programmed the time zone schedule and only ON / OFF is desired.
4. Enter the begin time hour (01-12) and minutes (01-59) then press *. [**_ _ _ _ * (beep)**]
5. Press 0 * for AM, **OR** press 1 * for PM. [**_ * (beep)**]
6. Enter the end time hour (01-12) and minutes (01-59) then press *. [**_ _ _ _ * (beep)**]
7. Press 0 * for AM, **OR** press 1 * for PM. [**_ * (beep)**]
8. Enter the days of the week that the time zone is to be active then press *. [**_ _ _ _ _ _ _ * (beep)**]
Sun = 1, Mon = 2, Tue = 3, Wed = 4, Thu = 5, Fri = 6, Sat = 7.
You can enter up to 7 numbers here (1-7). For example, for the time zone to be active only on Saturdays and Sundays, enter 1 7. The order of the numbers is not important; 17 is the same as 71.
9. Enter the relay number(s) that the time zone will apply to, then press *. [**_ * (beep)**]
You can enter a single relay number here; all relay numbers, or any combination of relay numbers. Valid relay numbers are 1 through 8.
10. Repeat steps 2 through 9 to program the other time zones.
11. Press 0# TOGETHER to end. [**0# (beeeeeep)**]

2.8 Miscellaneous

2.8.1 Restore Defaults

This step will restore the factory set defaults for each of the programming parameters.

WARNING: Once started, this sequence will program all values to factory default.

1. Press * 9 0 and enter the MASTER CODE. [* 9 0 _ _ _ _ (beep)]
2. Press 9 9 9 9 then press *. [9 9 9 9 * (beep)]
3. This sequence will end itself automatically. [beeeeeep]

2.8.2 Erase Transaction Log

This step will erase (empty) the transactions stored in the system history buffer (the system stores up to 500 transactions).

WARNING: Transaction log cannot be recovered after this sequence is started.

1. Press * 9 1 and enter the MASTER CODE. [* 9 1 _ _ _ _ (beep)]
2. Press 9 9 9 9 then press *. [9 9 9 9 * (beep)]
3. This sequence will end itself automatically in about 3 seconds. [beeeeeep]

SECTION 3 – ADJUSTMENTS

Speaker Volume

The speaker volume potentiometer is labeled SPEAKER VOL on the control board. The speaker volume should be adjusted for adequate sound. Adjusting the speaker volume too loud could cause feedback from the microphone.

1. Open the front of the telephone entry system and locate the speaker volume adjustment.
2. Place a call to a resident by entering a directory code on the keypad. While they are talking, adjust the speaker volume potentiometer for adequate sound. To increase the volume rotate the potentiometer clockwise, to decrease the volume rotate the potentiometer counter clockwise.

Microphone Gain

The microphone gain potentiometer is labeled MIC VOL on the control board. This adjustment increases or decreases the loudness in the telephone handset in the house.

1. Open the front of the telephone entry system and locate the Mic Vol adjustment.
2. Enter a directory code on the keypad to place a call to a resident. After they answer, adjust the microphone gain and ask the resident to let you know when the loudness in their telephone handset is set to a comfortable level.

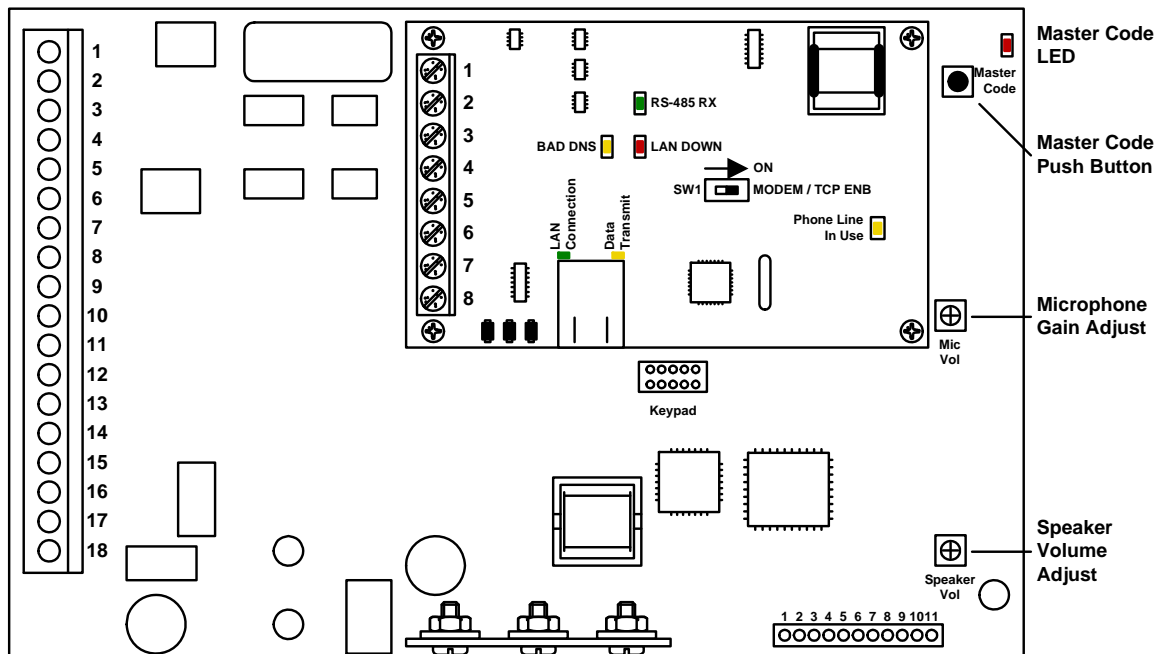

Interface Board LED Status

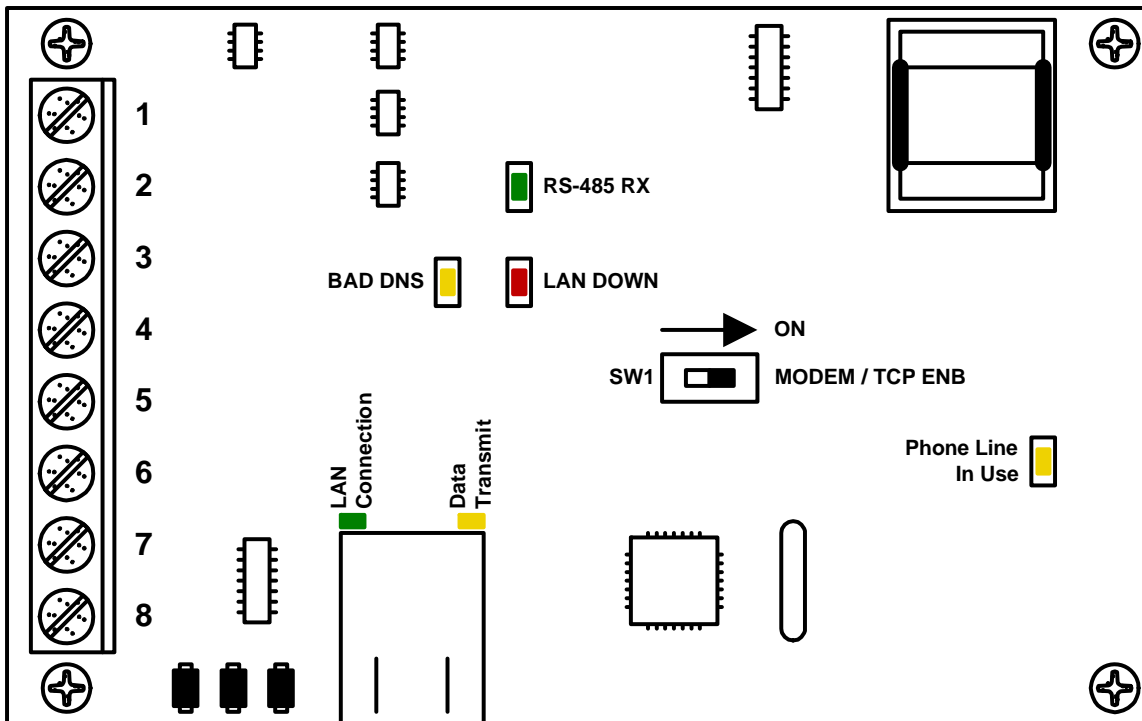

RS-485 RX

- Green LED indicates that the system is on-line and scanning the RS-485 devices.

BAD DNS

- Yellow LED indicates an email server problem, rejecting the mail server.

LAN DOWN

- Red LED indicates a problem with the LAN. IP or Gateway (router) down or wrong gateway IP address.

Phone Line In Use

- Yellow LED indicates that the phone line is in use.

LAN Connection

- Green LED indicates that the wire connection from the 1812 to the computer or router is good.

DATA Transmit

- Yellow LED indicates that the TCP / IP connection is transmitting data or sending an email.

SW1 - Modem TCP Enable

- Turning SW1 Off disables the modem and TCP / IP, but will speed up programming from the keypad.

SECTION 4 – USER INSTRUCTIONS

4.1 Resident Operating Instructions

4.1.1 *Granting or Denying a Guest Access*

To place a call from the Access Plus unit to a residence, the guest locates the directory code of the resident they want to visit, and then enters that code on the unit's keypad. Once the guest has been identified by voice communication, the resident may grant them access by pressing the appropriate tone open number, or they may deny access by simply hanging up or by pressing the programmed hang-up number.

1. To grant access to a guest, press the programmed tone open number. (The factory setting for the tone open number is 9, however this can be programmed to any number desired. See section 2.4.6 to program tone open numbers.) The Access Plus unit will respond with a confirming tone and will open the door or gate.
2. To deny access, hang up the telephone or press the programmed hang-up number.

4.1.2 *Call Waiting*

This feature is only available if the Access Plus unit is connected with the 1816 Access Plus interface and applies to directory codes 01-23 only. This feature is not available when the Access Plus unit is used as an auto-dialer.

When a resident is on their telephone and a guest enters their directory code on the Access Plus unit's keypad, the unit will sound a short tone in the resident's handset. This indicates to the resident that a guest is at the door or gate.

1. To place the outside call on HOLD and talk to the guest, press #.
2. To grant the guest access, press the programmed tone open number. The Access Plus unit will respond with a confirming tone, open the door or gate, and will reconnect the resident's phone with their outside call.
3. To deny the guest access, press #. The Access Plus unit will disconnect from the resident's phone and reconnect it to the outside call.

The same process can be used when the resident is talking to a guest at the Access Plus unit and an outside call comes in. The resident can place the guest on hold and switch to the outside call.

When using the Access Plus unit in the auto-dialer mode, it's a good idea for residents to subscribe to a call waiting feature offered by the phone company.

4.1.3 Dial-Connect (1816 intercom)

To use the dial-connect feature, the guest simply presses a two-digit directory code (01-23) on the Access Plus unit's keypad. The unit will automatically connect to the resident phone programmed under the directory code that was entered on the keypad. Once the call is answered, the person called may grant access by pressing the programmed tone open number or they can press the hang up number (2.4.8) to disconnect the call without granting access.

4.1.4 Dial-Out (auto-dial) Phone Numbers

To use the dial-out phone number feature, the guest simply presses a two-digit directory code (24-50) on the Access Plus unit's keypad. The unit will automatically dial out the phone number programmed under the directory code that was entered on the keypad (section 2.5.1). Once the call is answered, the person called may grant access by pressing the programmed tone open number or they can press the hang up number (2.4.10) to disconnect the call without granting access.

4.1.5 Access Codes

The simple access codes (five-digit entry code on the Access Plus unit's keypad) will operate either relay 1 or relay 2 depending on which relay they have been programmed to activate (2.6.1).

Keypad device access codes will operate the relay that they have been programmed to operate (2.6.1).

To use a keypad access code:

1. Press # then enter the access code [# _ _ _ _ _ (beeeeeep)]

When the access code is entered on the keypad, the system will check its memory to see if the code is programmed and will also check any time zone restrictions that may have been programmed for the specific code that was entered.

If the access code is a temporary code, the system will check the clock/calendar to determine if the current day falls within the programmed temporary access code boundaries (section 2.6.7).

4.2 Remote Operation

4.2.1 Remote Programming

The Access Plus unit can be programmed and operated from a remote location using a touch-tone telephone. Be sure that the ability for the unit to answer an incoming call has not been disabled (see 2.4.7).

Note: The Access Plus unit master code cannot be programmed remotely – it can only be programmed from the system keypad – see Programming the Master Code on page 32.

1. Call the unit's phone number. After the programmed number of rings (2.4.7) the Access Plus unit will answer with a tone.
2. Follow the desired programming steps in Section 2 of this manual.
3. When complete with the desired programming function, hang up. You cannot use 0# to end programming steps from a touch-tone telephone.

4.2.2 Remote Relay Activation

The Access Plus system relays can be activated from a remote (off site) location. Be sure that the ability for the Access Plus unit to answer an incoming call has not been disabled (see 2.4.7). Refer to the tone open numbers that were programmed in section 2.4.6 to determine each of the activation numbers.

- **Momentary Activation** (Relay activates for its programmed strike time)
- **Hold Open** (Relay will activate and remain activated).
- **Deactivate** (Relay will deactivate)
- **Hold 1 Hour** (Relay will activate for 1 hour and then automatically deactivate)

To activate the relay(s) from a remote (off-site) location, perform the following steps.

1. Call the phone number that the Access Plus unit is connected to. After the programmed number of rings (2.4.7) the unit will answer with a tone.
2. Press * 1 6 and enter the MASTER CODE. [* 1 6 _ _ _ _ (beep)]
(Two-way voice communication is also enabled at this point)
3. Enter the desired tone open number. [_ (beep)]
4. Hang up.

4.2.3 Relay Activation Check

The Access Plus unit can be called to check if relay 1, relay 2, or both relays on the unit's main circuit board are latched and holding a door or gate in the open (unlocked) position.

1. Call the phone number that the Access Plus unit is connected to. After the programmed number of rings (2.4.7) the unit will answer with a tone.
2. Press * 1 6 and enter the MASTER CODE. [* 1 6 _ _ _ _ (beep)]
3. Press * 7. [* 7 (beep)]
4. Listen for the following sequence of tones. **No tones:** neither relay is activated. Relay 1 activated: **beep** - pause - **beep** - pause . . . Relay 2 activated: **beep beep** - pause - **beep beep** - pause . . . Both relays activated: **beep beep beep** - pause - **beep beep beep** - pause . . .
5. Hang up.

SECTION 5 – MAINTENANCE

The DoorKing Access Plus system is essentially a maintenance free device. When the unit is properly installed, it should provide years of trouble free service. Maintenance is limited to updating the access codes and temporary access codes on an as needed basis.

The faceplate of the unit should be cleaned on a regular basis to keep contaminants in the air from sticking to the surface and possibly causing pitting. When cleaning the faceplate of the system, never use an abrasive cleaner or cloth. Stainless steel cleaner works very well with a soft cloth for systems with a stainless steel faceplate. A clean damp soft cloth should be used to clean gold plated faceplates.

Directories

The Access Plus Account Manager software will print a directory for either the 1810 Access Plus or the 1808 Access Plus. The directory can then be easily inserted into the respective unit.

5.1 Troubleshooting

If problems should develop with your telephone entry system, refer to the trouble-shooting guide on the following pages to try and correct any problems. Our experience has shown that a majority of reported problems are actually programming related and can be corrected on site. If problems persist and they cannot be corrected, contact your authorized DoorKing dealer for assistance. Before performing any troubleshooting, check the following:

1. Have a good VOM meter handy to check voltages and continuity.
2. Have a telephone test set (DoorKing p/n 1800-050 or equivalent) to check the telephone line. Noise on the phone line will cause problems with the entry system.
3. Be sure that the entry system case is properly grounded.
4. Be sure that the telephone wires are twisted.
5. A hum on the system indicates that the phone line or 16 VAC power lines may be grounded. Check to be sure that the phone lines or power lines are not shorted to ground. Be sure that the cable used for communication is a twisted pair, good quality phone cable insulated for direct underground burial. Using phone wire that is designed for indoor use only can absorb moisture and cause a hum on your phone line.
6. Check the 16 VAC system power. Be sure that the transformer is properly rated (20 VA). Keep the wire run from the transformer to the entry system as short as possible. Use 16 or 18 AWG, 600 volt insulated wire only. **The importance of proper power wiring cannot be over stressed!**

5.2 Troubleshooting Tables

SYMPTOM	POSSIBLE SOLUTION(S)
Cannot get into programming mode.	<ul style="list-style-type: none"> • Wrong master code entered. Start over. • Waiting too long between pushing buttons. Enter information quicker. • Keypad is not plugged into board correctly. Cable points down.
System emits a long tone and cancels programming.	<ul style="list-style-type: none"> • Waiting too long between pushing buttons. • Forgetting to press * first when programming.
Keypad is dead.	<ul style="list-style-type: none"> • No power. Check for 16 VAC input power. • Check that the keypad is properly connected to the circuit board. The cable on the plug points down when connected to the circuit board.
Buzz or noise on the line.	<ul style="list-style-type: none"> • Check for a short to ground behind the circuit board. • Check for pinched wires near the door hinge. • Check for 16-volt power shorted to a conduit. • Check for a phone line shorted to ground. • Check that the phone wires are twisted. • Check that all wires, speaker, keypad, etc., are isolated from ground. • Check that the cabinet is properly grounded. Be sure case ground (terminal 3) is not used as a low voltage common. • Check for excessive voltage drop on 16 VAC power. • Check phone line with telephone test set.
System will not answer when called from a remote location.	<ul style="list-style-type: none"> • Answer incoming call feature is turned off. Turn answer incoming call feature on. • Number of rings to answer may be programmed too high. Reprogram number of rings to answer.
Electric strike locks on or gate operator holds open.	<ul style="list-style-type: none"> • Excessive voltage drop on 16 VAC line. • Hold open schedule is enabled. Turn off hold open schedule or reprogram time zone. • Access code used was programmed under a hold location code. Reprogram access code into a momentary activation location code. • A hold command was sent to the relay from the resident's phone. Deactivate the relay using the resident's phone.
Access code will not work.	<ul style="list-style-type: none"> • Forgetting to press # first. • Access code is time zone restricted and the access code time zone is enabled. Turn access code time zone off, reprogram time zone boundaries or reprogram access code without a time zone.

5.3 Wire Diagram

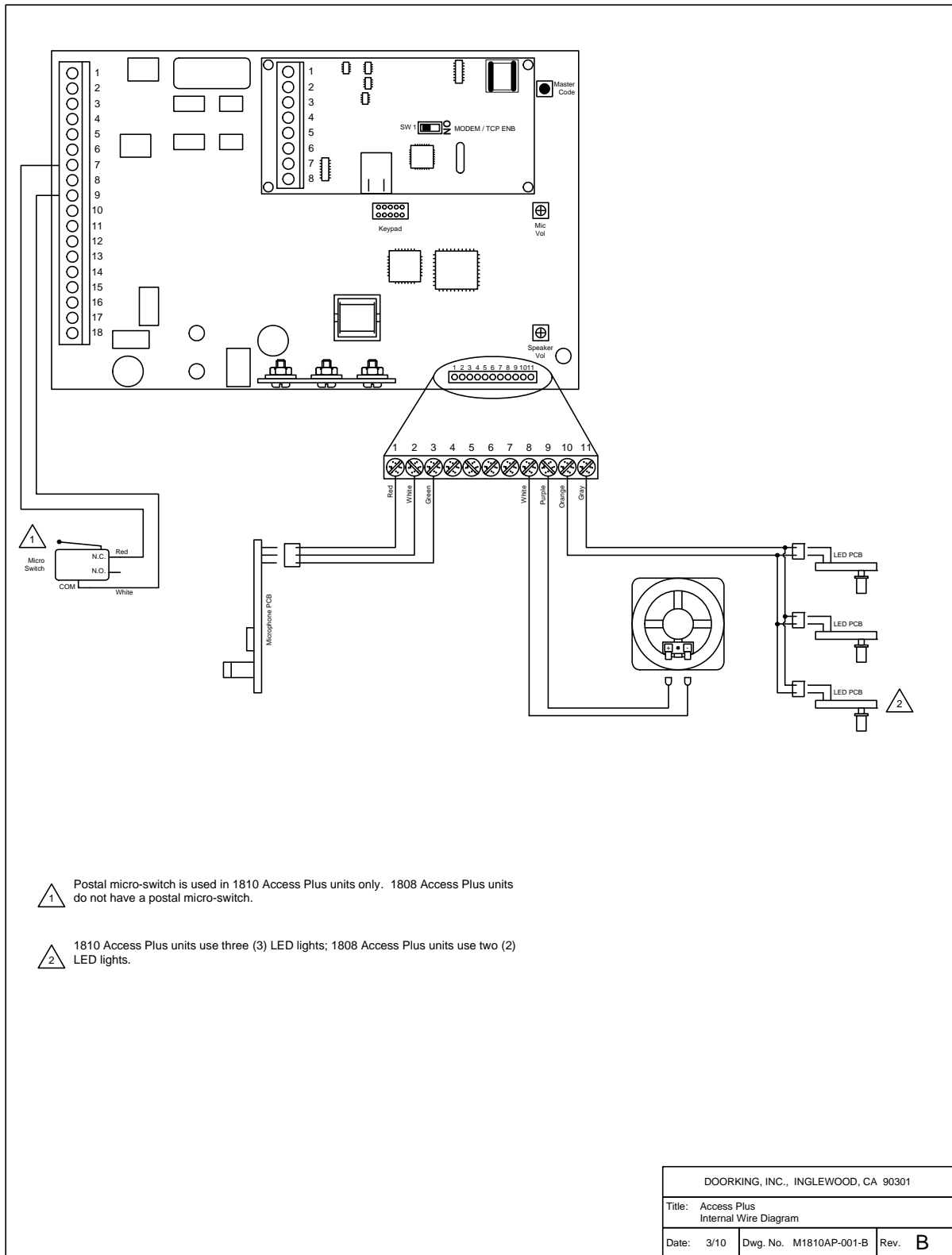

1 Postal micro-switch is used in 1810 Access Plus units only. 1808 Access Plus units do not have a postal micro-switch.

2 1810 Access Plus units use three (3) LED lights; 1808 Access Plus units use two (2) LED lights.

DOORKING, INC., INGLEWOOD, CA 90301		
Title: Access Plus Internal Wire Diagram		
Date: 3/10	Dwg. No. M1810AP-001-B	Rev. B

5.4 Accessories

RS-485 Card Reader	P/N 1815-232 (DKS Reader)
RS-485 Card Reader	P/N 1815-233 (AWID Reader)
RS-485 Card Reader	P/N 1815-234 (HID Reader)
RS-485 Keypad	P/N 1513-080 (Non-lighted)
RS-485 Keypad	P/N 1513-081 (Lighted)
RS-485 Keypad	P/N 1513-082 (Flush Mount)
RS-485 Receiver	P/N 8053-080 (MicroPlus)
Relay Board	Relay board allows almost any 26-bit wiegand device to be added to the Access Plus system (converts 26-bit wiegand to RS-485) and can also be used to add another relay to the system. P/N 1815-235.
Secondary Keypad	Allows remote activation of the system relays by use of the access codes. Does not provide any voice communication to the main unit or to the resident telephone. P/N 1812-082.
Surge Suppressers	High voltage (115 V) suppresser. P/N 1876-010. Phone line suppresser. P/N 1877-010. Low voltage (28 V) suppresser. P/N 1878-010.
Mounting Post	P/N 1200-045 Standard Gooseneck Pad Mount P/N 1200-046 Standard Gooseneck In-ground Mount P/N 1200-037 Architectural Style Gooseneck Pad Mount (1810 AP only) P/N 1200-038 Architectural Style Gooseneck In-ground Mount (1810 AP only) P/N 1200-037 Architectural Style Straight Pad Mount (1810 AP only) P/N 1200-038 Architectural Style Straight In-ground Mount (1810 AP only) P/N 1200-086 Designer Style Gooseneck Pad Mount (1810 AP only) P/N 1200-085 Designer Style Straight Pad Mount (1810 AP only)
Telephone Test Set	Includes clips, cord and carrying case. P/N 1800-050.
Battery	12 volt .8 amp hour gel cell provides stand by power during power interruptions. P/N 1801-008.
Postal Lock Box	Provides a means for the mail carrier to enter the premise to deliver mail. P/N 1402-080.
CCTV Camera	Camera mounted in phone system. P/N 1812-147. Requires additional CCTV components.
Magnetic Locks	A variety of magnetic locks are available to meet individual application requirements. Contact your DoorKing dealer.
Electric Strikes	A variety of electric strikes are available to meet individual application requirements. Contact your DoorKing dealer.

5.5 Tables

Complete the information in the tables on the following pages to maintain a record of the information that has been programmed into the 1810 entry system.

MASTER CODE			

Tone Number Function	Relay							
	1	2	3	4	5	6	7	8
Momentary								
Hold								
Release								
Hold 1 Hr.								

Access Code Time Zone Schedules				
	Zone 1	Zone 2	Zone 3	Zone 4
Begin Time				
End Time				
Days of Week				
Relays				

Hold Open Schedules				
	Schedule 1	Schedule 2	Schedule 3	Schedule 4
Begin Time				
End Time				
Days of Week				
Relays				

Directory Codes / Dial-Connect

Directory Code	Name	Apartment Number
02		
03		
04		
05		
06		
07		
08		
09		
10		
11		
12		
13		
14		
15		
16		
17		
18		
19		
20		
21		
22		
23		

Directory Codes / Auto-Dial Numbers

Directory Code	Name	Phone Number
24		
25		
26		
27		
28		
29		
30		
31		
32		
33		
34		
35		
36		
37		
38		
39		
40		
41		
42		
43		
44		
45		
46		
47		
48		
49		
50		

